

DESIGN AND IMPLEMENTATION OF A PLC BASED
AUTOMATIC CAR WASHING SYSTEM

BY

TIJANI YUNUS OLAMIDE

(MEE/13/1164)

A project report submitted to Mechatronics Engineering Department

Federal University Oye Ekiti in partial fulfillment

of the requirements for the award of the B. Eng (Hons) in

Mechatronics Engineering

Department of Mechatronics Engineering

Faculty of Engineering

2018



APPROVAL

This project report has been approved for the acceptance by the Mechatronics Engineering department, Federal University Oye-Ekiti, Ekiti state and meets the regulations governing the award of the bachelors of engineering of FUOYE.

By

Supervisor

Name: Engr. Dr. Arowolo

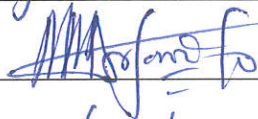
Signature: 

Date: 26/3/2019

Head of Department

Name: Engr. Dr. Arowolo M.D

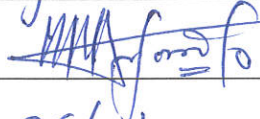
Signature: 

Date: 26/3/2019

External examiner

Name: _____

Signature: _____

Date: _____

TABLE OF CONTENTS

APPROVAL	iii
LIST OF FIGURES	vii
LIST OF TABLES.....	viii
LIST OF ABBREVIATIONS.....	ix
DEDICATION.....	x
ACKNOWLEDGEMENT	xi
ABSTRACT.....	xii
DECLARATION.....	xiii
CHAPTER ONE	1
INTRODUCTION.....	1
1.1 PROJECT BACKGROUND.....	1
1.2 PROBLEM STATEMENT	2
1.3 AIMS AND OBJECTIVES	3
1.4 SCOPE OF STUDY.....	3
1.5 RESEARCH CONTRIBUTION TO KNOWLEDGE	3
1.6 REASON FOR USE OF PLC TO CONTROL SYSTEM.....	4
CHAPTER 2.....	5
LITERATURE REVIEW	5
2.1 DEFINITONS OF TERM:.....	5
2.1.1 CAR:	5
2.1.2 CAR WASHING.	5
2.1.3 CAR WASHING SYSTEM.....	6

2.2	CATEGORIES OF CAR WASHING:.....	6
2.3	PLC	7
2.3.1	HARDWARE OF PLC SYSTEM	7
2.4	HOW A PLC OPERATES.....	8
2.5	PROGRAMMING PLCS.....	9
2.6	RESEARCH ON EXISTING JOURNALS	10
CHAPTER 3		18
METHODOLOGY		18
3.1	DESIGN DESCRIPTION	18
3.2	DESIGN CONSIDERATION.....	18
3.3	PARTS OF THE MACHINE AND ITS FUNCTIONS:.....	19
3.4	OPERATING PRINCIPLE.....	19
3.5	WORKING PRINCIPLE	20
3.6	BLOCK DIAGRAM OF SYSTEM.....	22
3.7	WORKING PROCEDURE.....	22
3.8	HARDWARE COMPONENTS OF THE SYSTEM.....	24
3.9	COMPONENTS OVERVIEW	25
3.10	INPUT AND OUTPUT ADDRESSING	37
3.11	CONCEPT OF VFD TO CONTROL MOTOR SPEED.....	38
3.12	SYSTEM IMPLEMENTATION	39
3.12.1	MECHANICAL DESIGN AND IMPLEMENTATION	39
3.12.2	ELECTRICAL CIRCUIT DESIGN AND IMPLEMENTATION	39

3.12.3	CONTROL PANEL.....	40
3.12.4	CONTROL SECTION AND IMPLEMENTATION.....	41
3.13	PROGRAMMING FLOWCHART	42
3.14	DESIGN CALCULATION FOR CONVEYOR.....	43
CHAPTER 4	48
RESULT AND DISCUSSION	48
4.1	RESULTS AND ANALYSIS.....	48
4.2	DISCUSSION.....	49
4.3	MAINTENANCE	49
4.4	IMPLEMENTED PROTOTYPE.....	50
CHAPTER 5	51
CONCLUSION AND RECOMMENDATIONS	51
5.1	CONCLUSION.....	51
5.2	HIGHLIGHTS OF IMPLEMENTATION:.....	52
5.3	RECOMMENDATION	52
REFERENCES	53
APPENDIX A	55
BILL OF ENGINEERING MATERIALS AND EVALUATION	55
APPENDIX B	56
ELECTRICAL CIRCUIT DESIGN I	56
APPENDIX C	59
CONTROL SECTION – LADDER LOGIC PROGRAMMING	59

LIST OF FIGURES

Figure 2.1: Car	5
Figure 2.2: Car Washing	5
Figure 2.3: Manual car washing	6
Figure 2.4: PLC Architecture	7
Figure 2.5: Programming Languages	9
Figure 2.6: Block Diagram of System	11
Figure 3.1: Schematic diagram of a working automatic car washing system	19
Figure 3.2: Inductive Sensing	31
Figure 3.3: Block Diagram of the system	22
Figure 3.4: Zelio PLC	25
Figure 3.5: Universal AC Motor	26
Figure 3.6: Motor components	27
Figure 3.7: Equivalent Circuit of Motor	27
Figure 3.8: Inductive sensor	28
Figure 3.9: Dryer Exhaust fan	28
Figure 3.10: Omron Relay	29
Figure 3.11: Contactor	30
Figure 3.12: Circuit breaker	31
Figure 3.13: Power Supply	31
Figure 3.14: Variable Frequency Drive	32
Figure 3.15: DC Pump	34
Figure 3.16: Push button	34
Figure 3.17: LED	35
Figure 3.18: Terminal block	36
Figure 3.19: Conveyor belt	36
Figure 3.20: Cloth brush	37
Figure 3.21: Control Panel	41
Figure 3.22: Programming Flowchart	42
Figure 4.1: Implemented Prototype	50

LIST OF TABLES

Table 1: System Components of the Automatic Car Washing System.....	24
Table 2: Input Addressing.....	37
Table 3: Output Addressing.....	38
Table 4: Timing at each station.....	48

LIST OF ABBREVIATIONS

PLC	-	Programmable Logic Controller
MCCB	-	Miniature Current Circuit Breaker
VFD	-	Variable frequency drive
AC	-	Alternating current
DC	-	Direct Current
HMI	-	Human Machine Interface
CPU	-	Central Processing Unit
I/O	-	Input and Output
IL	-	Instruction List
ST	-	Structured Text
FBD	-	Function Block Diagram
LD	-	Ladder Diagrams
SFC	-	Sequential Function Chart
SMPS	-	Switch Mode Power Supply
GUI	-	Graphical User Interface
USB	-	Universal Serial Bus
IR	-	Infrared radiation
RFID	-	Radio frequency identification
GSM	-	Global system for mobile communication

DEDICATION

I dedicate this project to God Almighty for facilitating this work, His endless mercy, grace and for granting me the opportunity to be surrounded by great and helpful people at Federal University Oye Ekiti.

ACKNOWLEDGEMENT

I would like to begin the articulation of my sentiments and thoughts for the successful completion of this B.Eng Programme at the Federal University Oye Ekiti, Ekiti State, by paying homage and giving honour to Him to whom all honour is due – Almighty Allah. It has been His Grace and Enablement that saw me through it all.

Secondly, my deepest thanks go to you, Dr. Oluwole Arowolo, my supervisor for his valuable encouragement, guidance and monitoring, without which this work would not have reached the point of fruition, so we ask Almighty God to reward him on our behalf.

Many thanks is given to all my lecturers in person of Dr. Adekunle, Dr. Balogun, Dr. Obaji, Dr. Obiazi, Engr. Aribisala, Engr. Martins, Mr. Otenaike for the impact you have made throughout our stay and for your support and advice.

No acknowledgment would be complete without expressing my appreciation and thankfulness to my father and mother in person of Mr. and Mrs. Tijani, my sisters in person of Semira, Aisha, Fatima, Mariam and all my families' members for their unconditional and invaluable support in the entire life; I would never forget your continuous prayer for the sake of my success and the financial support.

At last and not least, our gratitude goes to my beloved friends; Mause, Seun (Padre), Sweet Boys Association, Quadri, Micheal; who have made positive impact in my live. I will like to appreciate the support and encouragement from our fellow departmental mates.

ABSTRACT

In this new era, innovation has extended its arm into different aspect of life especially in the transportation field. This development has led to an increase in producing smarter vehicles for transportation. Thus, requiring an appropriate automatic washing framework to wash and maintain cleanliness of these vehicles. This project involves the design and construction of a PLC based automatic car washing system with the aim of reducing water waster by incorporating a recycling system. The traditional means of washing vehicles was time consuming, involved lots of manual power and led to water pollution of the environment. This system is designed using aluminum metal to fabricate the framework. The system is implemented using three means, namely: Mechanical, Electrical and Programming means. The machine was designed to use an induction electric motor to move the car on the conveyor belt from one workstation to the next incorporating the use of a VFD to reduce the speed of the motor incorporating the use of a PLC to control the logical operations of the system with the use of sensors and actuators. Also, the system made use of a filter net to separate dirt from used water in order to allow recycling of the system by pumping it back into the system. After testing the automatic car washing system, it performed the car washing process efficiently from one work station to another and reduced water wastage by recycling the water.

Keywords: PLC, Conveyor belt, AC Motors, Proximity Sensors (Inductive type), Variable frequency drive (VFD), Relay, Dryer, Brush.

DECLARATION

I, Tijani Yunus Olamide hereby declare that the project work entitled “**Design and Implementation of a PLC based Automatic Car Washing System**” submitted to Mechatronics Engineering department, Federal University Oye-Ekiti (FUOYE), is a record of an original work done by myself under the supervision of Dr. Oluwole Arowolo in Mechatronics Engineering department of Federal University Oye-Ekiti. This project is submitted in partial fulfillment of the requirement for the award of the degree of bachelor of Engineering in Mechatronics Engineering. This project has not been submitted to any other institution for the award.

 26/3/2019

TIJANI YUNUS OLAMIDE

MEE/13/1164

CHAPTER ONE

INTRODUCTION

1.1 PROJECT BACKGROUND

Considering the rate at which development has occurred over time, the interest to perform errands or activities at a faster rate is being laid out as well. In the cutting edge world, innovation has connected every town, city and nation with the other through advanced means. This has in the long run prompted a monstrous increment in the quantity of vehicles. Vehicles are used extensively for transportation. It is important to have an easy and effective system for maintaining these vehicles cleanliness. To clean these vehicles, there is a need of an appropriate washing framework with the aim of using less water by recycling.

Car washing is a simple activity done in order to keep the exterior and interior of a car clean and neat. Today, in this modern era, automation has extended its hands in various fields. Automation process for car washing system is significantly proven as a mechanism for time management and a means for an efficient output. With the modern convenience of automatic car washes, it may be difficult to remember that the industry was not always so high-tech. Traditionally, car washing was done manually at driveway, verandas, automobile garage which was tedious, time consuming and human errors led to imperfection in work progress and wastage of resources. Dating back to the dawn of car washing in 1946, people used manpower to push or move the cars and specific piece of equipment. Each worker had a designated task, such as applying soap, rinsing the car or drying it through stages of the car washing process. Eventually, manual car wash operation evolved into the use of automatic pulley systems to pull cars along the tunnel, but employees still had to scrub down manually with brushes and dry the vehicles (Akilandeswari, 2004).

Consecutively, development occurred and resulted into a mechanized car washing system which involved performing the car washing processes on a car wash rack. This mechanized system of washing cars consisted of the use of wrap-around brush, roller-on-demand conveyor belt, soft cloth for the wheel and tire washing. Car washing evolved into the use of an overhead sprinkler that would wet down the vehicle, but again, workers still had to scrub. The car washing process found complete automation when nozzles to apply soap and water, automated brushes and a 50-horse power dryer was incorporated into the system.

This automated car washing system required customers to drive their vehicles onto the conveyor, allowing the washing and drying process to take place.

Finally, another car wash innovation was introduced with automated express car washing system which included an automated pay terminal and gates. This system had all necessary for express exterior car wash like pay stations, customer convenience, short time, and built for accepting a few number of cars at once avoiding delay. This system allowed customers to pull up to the terminal, purchase a wash with cash or credit card, the gate would raise and the car would be added to the queue of the tunnel. The attendant at the wash entrance would only need to guide the person onto the conveyor to begin the car wash system. The benefit of this system includes, labor savings, higher wash volumes and improved wash quality.

Looking to the past and studying the evolution of car wash system, there have been various types of car washes but each has its own setback. Some of these setbacks include cost, increased number of employees, time consumption, resource wastage, high level of manual labour, low number of car wash resulting to low income and even in some instances dissatisfaction from customers due to poor job output.

Due to advent of sensors, they are equipped with the newer models of car washing system. They help with the automation processes by sensing the physical world and taking the next step based on the instruction stored in its memory.

1.2 PROBLEM STATEMENT

Existing models of car washing system have contributed to the pollution of the environment and contamination of soil and underground water. It was observed that these car washing system discharges used soapy water into the ground which arises from the rinse of the car which eventually drains to rivers and lakes. The chemicals in the soap water is harmful to the soil and could destroy the soil structure depositing harmful substances into the ground which could in turn pass into the crop yield from the soil. A chief pollutant in such wash-water includes phosphates, oil and grease and lead.

Further, it was noticed that brushes used in existing model caused micro-scratches to the finishes of the vehicles during its brushing process. This scratch creates a sense of displeasure to the owner of the vehicle considering the cost to correct such damage.

The model was thus redesigned eliminating the above problem by designing the washer such that it will contain two separate container for soap solution and water both

embedded in the same machine and can be ejected as the user desire i.e. only soap solution, only water or a mix of water and soap solution. Along with that it will also have an attached and rotating scrubber or brush. So the user can use it directly after applying soap solution to the car body, which will result in a faster and less tedious cleaning operation. Also, the new model incorporated a filtration system which filters dirt from the used soap water and recycles it into the soap container to reduce water wastage.

1.3 AIMS AND OBJECTIVES

The aim of the project is to design and implement a PLC based automatic car washing system while the objectives of this project are to:

- (i) Perform exterior car washing automatically using a Programmable Logic Controller (PLC);
- (ii) Reduce water wastage by incorporating a filtration recycling system; and
- (iii) Ensure the system performs the cleaning process in a short time.

1.4 SCOPE OF STUDY

The scope of this project is to achieve the objectives of this project with the design, fabrication and implementation of the system by:

- (i) Modeling the system to conceptualize its working process.
- (ii) Simulating, debugging and downloading the ladder logic program using into the Programmable Logic Controller (PLC).
- (iii) Designing, simulating and testing the electrical control system for the system.
- (iv) Fabricating the framework of the system and installation of the conveying system.

1.5 RESEARCH CONTRIBUTION TO KNOWLEDGE

The rationales of this research done are:

- (i) To incorporate the use of a Programmable Logic Controller (PLC) considering the fact that it's more robust, rugged and is more flexible.
- (ii) To introduce an efficient system of reducing water wastage by incorporating a filtration recycling system. Thus, avoiding environmental pollution and water contamination.

- (iii) To reduce waste water effluent from car wash sector from any hazardous heavy metal into the environment which is will conducted to water pollution.
- (iv) To aid the development of automation.

1.6 REASON FOR USE OF PLC TO CONTROL SYSTEM

- i. Very High Accuracy
- ii. Low Power Consumption (Energy Saving)
- iii. High Level human Safety
- iv. Less Running cost
- v. Small in Size (Requires less space)
- vi. Rugged Construction
- vii. Easily programmable
- viii. Easy Maintenance
- ix. Economical & high flexibility
- x. Shorter project program
- xi. Easy Documentation

CHAPTER TWO

LITERATURE REVIEW

2.1 DEFINITONS OF TERM:

2.1.1 CAR: This is defined as a road vehicle, usually with four wheels and powered by an internal-combustion engine, designed to carry a small number of passengers or load (encarta dictionary).



Figure 2.1: Car

2.1.2 CAR WASHING: Car washing is a simple activity done in order to keep the exterior and interior of a car clean and neat. This activity involves the use of soapy water to wash of dirt's from the car surface with the use of brush and rinsing of the car without damaging the paint finish of the car.



Figure 1.2: Car Washing

2.1.3 CAR WASHING SYSTEM: A car wash system is a facility used to clean the exterior and, in some cases, the interior of motor vehicles.

2.2 CATEGORIES OF CAR WASHING:

- (i) Hand car wash – This is a type of car wash where the washing process is done manually by employees of the facility.



Figure 2.2: Manual car washing

- (ii) Self-service wash – This is a type of car wash where the customer does the washing by himself involving the use of a pressurized jet washing equipment. .
- (iii) In-bay car wash – This is a type of car wash that consists of an automatic washing machine and dryer that rolls back and forth over a stationary vehicle. This is often seen at filling stations and stand-alone wash sites.
- (v) Tunnel car wash – This is a type of car wash which uses a conveyor to move the vehicle through a series of fixed cleaning mechanisms.
- (v) Chemical car wash – This is also known as waterless car wash. It uses chemicals to wash and polish car surface. This car wash is recommended only for cars with light dirt accumulation to avoid paint damage.
- (vi) Steam car wash – This is a type of wash that uses a jet of steam, detergent injection and micro fiber towels to wash the car.
- (vii) Mobile car wash – This is often also serving as mobile detailing systems, which carry plastic water tanks and use pressure washers. Sometimes these systems are mounted on trailers, on trucks, or in vans. Generally these operators also have a generator to run a shop vac., buffers, and other tools as well.

- (viii) Self-serve car wash – This is a simple and automated type of car wash that is typically pay operated self-service system. The vehicle is parked inside a large covered bay that is equipped with a trigger gun and wand (a high-pressure sprayer) and a scrub foam-brush.
- (ix) Touchless in-bay wash – This is a type of car wash that was developed as an alternative to automatic car washes using brushes in order to avoid marking paintwork. During the friction zone of a conveyORIZED car wash, a touchless car wash forgoes brushes and uses high water pressure plus chemicals to clean the vehicle which minimizes the chance of surface damage to the vehicle.

2.3 PLC

Programmable Logic Controller (PLC) is a special form of microprocessor-based controller that uses programmable memory to store instructions and to implement functions such as on/off control, sequencing, timing, counting, and arithmetic in order to control machines and processes.

2.3.1 Hardware of PLC system

Typically a PLC system has the basic functional components, as shown below. They comprise of:

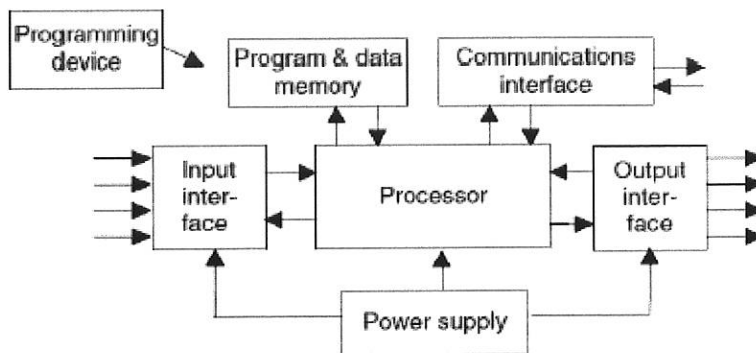

Figure 2.3: PLC Architecture

- i. The processor unit or central processing unit (CPU) is the unit containing the microprocessor and this interprets the input signals and carries out the control actions, according to the program stored in its memory, communicating the decisions as action signals to the outputs.

- ii. The power supply unit is needed to convert the mains A.C voltage to the low D.C voltage (5 V) necessary for the processor and the circuits in the input and output interface modules.
- iii. The programming device is used to enter the required program into the memory of the processor. The program is developed in the device and then transferred to the memory unit of the PLC.
- iv. The memory unit is where the program is stored that is to be used for the control actions to be exercised by the microprocessor and data stored from the input for processing and for the output for outputting.
- v. The input and output (I/O) sections are where the processor receives information from external devices and communicates information to external devices. The inputs might thus be from switches, sensors such as photo-electric cells, temperature sensors, or level sensors, etc. The outputs might be to motor starter coils, solenoid valves, etc.
- vi. The communications interface is used to receive and transmit data on communication networks from or to other remote PLCs. It is concerned with such actions as device verification, data acquisition, synchronization between user applications and connection management.

2.4 HOW A PLC OPERATES

PLCs consist of input modules or points, a Central Processing Unit (CPU), and output modules or points. An input accepts a variety of digital or analog signals from various field devices (sensors) and converts them into a logic signal that can be used by the CPU. The CPU makes decisions and executes control instructions based on program instructions in memory. Output modules convert control instructions from the CPU into a digital or analog signal that can be used to control various field devices (actuators). A programming device is used to input the desired instructions. These instructions determine what the PLC will do for a specific input. An operator interface device allows processing information to be displayed and new control parameters to be entered.

2.5 PROGRAMMING PLCS

Programs for use with PLCs can be written in a number of formats. Most PLC manufacturers adopted ladder-logic for writing programs. However, each tended to develop its own versions and so an international standard has been adopted for ladder programming and indeed all the methods used for programming PLCs. The standard, published in 1993, is International Electrotechnical Commission IEC 61131-3 include 5 programming languages as shown in **Figure 1.5** below:

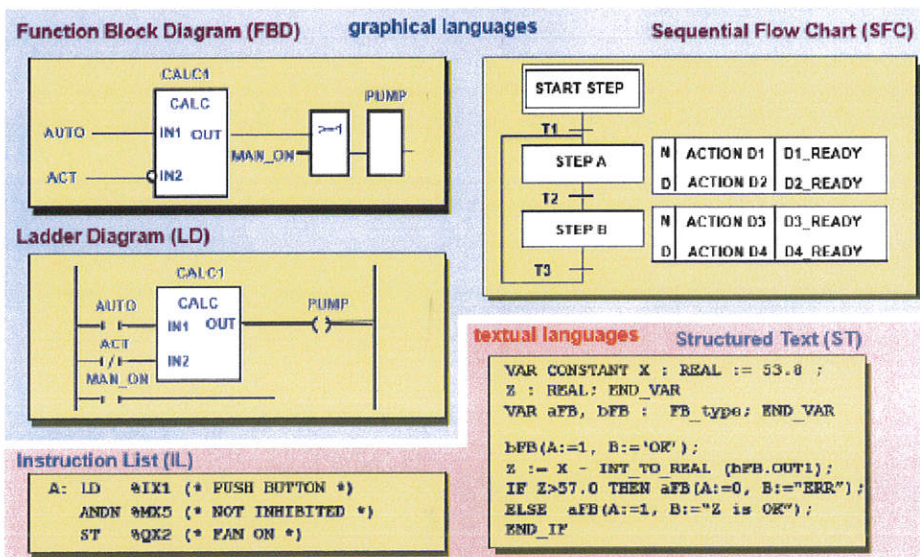

Figure 2.4: Programming Languages

- i. **Instruction List (IL)** is a convenient assembler-like programming language. IL is universally usable and is often employed as a common intermediate language to which the other textual and graphical languages are translated.
- ii. **Structured Text (ST)** is a textual language of IEC 61131-3. ST is called a High-Level Language, because it does not use low level, machine-oriented operators but offers a large range of abstract statements describing complex functionality in a very compressed way.
- iii. **Function Block Diagram (FBD)** is a graphical language similar to Structured Analysis. Controllers are modeled as signal and data flows through processing elements (*function blocks*). FBD transforms textual programming (ST) into connecting (already defined) building blocks, thus improving modularity and software reuse.

- iv. **Ladder Diagrams (LD)** is an evolution of electrical wiring diagrams. LDs supply a programming style borrowed from electronic and electrical circuits. This programming language is primarily designed for processing Boolean signals (1 \equiv TRUE or 0 \equiv FALSE).
- v. **Sequential Function Chart (SFC)** is primarily a graphical language, although a textual description is also defined. SFC was defined to break down a complex program into smaller manageable units and to describe the control flow between these units. Using SFC, it is possible to design sequential and parallel processes.

2.6 RESEARCH ON EXISTING JOURNALS

Vivek Kumar Yadav *et. al*, (2016) proposed a prototype using a Programmable Logic Controller (PLC) which cleans up a car immediately the system senses the car with sensors. He stated the system used a Switch Mode Power Supply (SMPS) to power the entire system. The prototype was made of an aluminum casing on which the conveyor belt was connected. DC motors was used to rotate conveyor and brushes. The system was divided into five different sections ranging from the entry, spraying, brushing, drying and exit section. The washing process is achieved according to the instructions stored in the PLC.

Pranoti Utekar *et. al*, (2015), designed a model to wash the exterior a car using two robotic arms. The two robotic arms are mounted at base of longitudinal wall and other on the ceiling. The car whose surface is to be cleaned is stationed onto a rotating platform. Robotic Arm1 is used for cleaning the sides of the car. It consists of a circular brush at the end of the arm. The arm rotates and captures the wheel base; with rotatory movement of the circular brush it cleans the wheels. The remaining surface is cleaned by a wiper like movement of the arm. Robotic Arm2 is used for cleaning the front and back of the car. It is so programmed that it can travel along the surface to wipe it. Both the arms will work according to the inputs from Graphical User Interface (GUI). The GUI sends this information to microcontroller through PC by using USB to UART converter. This system was implemented with servo motors on the robotic arm which acts as fingers of a hand. Servo motors were used because of its speed, torque and degree of rotation as compared to a stepper motor. 3 servo motors were used at the base and at both arms. Also, this system made use of IR sensors. The IR sensors

were placed at the roof of the room to detect the size of the car. These IR sensors were interfaced with the water spouts to control the use of water. The water spouts will remain open considering the IR sensor senses the presence of the car.

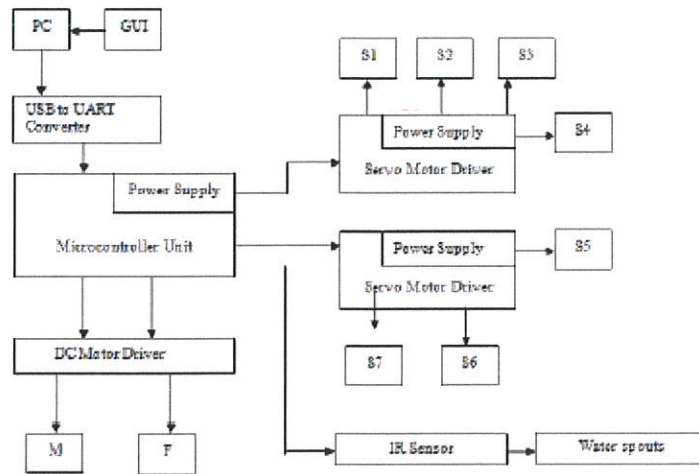

Figure 2.5: Block Diagram of System

According to Vidyasagar *et. al* (2015), wrote a paper that focused on a working prototype model of a RFID-GSM Autonomous Car Washing System. This system uses a conveyor belt mechanism that is introduced to transfer the car from entry point to the work station. The IR sensor technology in the system is used to sense the entry level detection of the car to be washed and at the workstation to initiate the washing process. This project incorporated the use of a circular disc mounted to the shaft of the Johnson geared motor used as base to hold the car for washing.

The washing process of this system is enabled by using a sprinkler and dryer mechanism. A dust particle detection sensor is used to trace the dirty surface on any location of the car. The Zero signal from the sensor causes to open the exit level of the car. An RFID-GSM technology is incorporated to dispatch the car for delivery and the washing status completion is informed to the car owner using GSM technology. The system used a PIC 16F778A micro controller for the car washing system.

In another way Shigen Zhong *et al.* (2017) proposed the Internet of Things-based concept about automatic car washing mode. This journal states that the automatic car washing uses some technologies like Internet of Things and big data to construct car wash cloud and terminal interface, which bridges cloud operators, car-washing shops, car washer manufacturers and customers. This mode creates Car-wash Cloud, integrates the operators on



this cloud, the car washer and excellent manufacturers of automatic car washer and reconstructs the chain of automatic car washing mode. Wherever the car is, the driver can drive to the nearest car wash to enjoy automatic car washing then make a judgment on its service. This platform is based on Linux operating system, which is a stable multi user network operating system. This architecture is divided into 5 layers: data layer, data access layer, services layer, authorization and access control layer and application layer. The data layer uses an open source MySQL database that can be distributed or clustered according to performance requirements.

Also, Mhaske *et al.* (2016) presented this paper to show an ideal opportunity to clean vehicle using a programmed auto washing venture utilizing a transport line on which clients stop their vehicles for a cleaning process to occur. This system made use of a Webcon PLC which was associated with the PC through a RS-232 correspondence link for downloading or transferring the system. They utilized a 100 rpm DC engines for driving the transport line through pulley and for driving brushes to move the auto through the different phases of washing. When a switch is pressed, the transport line begins to move and a clock is set on transport line at better places for auto recognition. At the point when the vehicle is recognized, it stops the transport line and begins a valve at the same time through water on auto comparably at various levels when an auto is identified it will utilize brushes, cleanser, and drier to clean the auto. Appropriate clasp of auto wheels on the transport was required with a specific end goal to keep away from relocation. High weight spouts were pointed at different position for splashing cleanser and water to clean hard to achieve parts of the vehicle. Toward the end, hot steam air is for the most part utilized for drying the auto.

Then, in 2014, Akilandeswari proposed this paper with the main objective of performing an exterior car wash automatically using a Programmable Logic Controller integrated with a GSM Modem. This GSM-PLC sends status information like entry, exit of a car, emergency shutdown to the customer or operator through SMS. After acquiring the information from PLC, the operator can able to act upon it. They considered the use of a HORNER PLC which was connected to the PC through a RS-232 communication cable for downloading or uploading the program. They used 100 rpm DC motors for driving the conveyor belt via pulley and for driving brushes. An Infrared sensor was used which emits radiation in order to sense presence of car at the entry level. Once the Infrared radiation is cut by the car an input signal is given to PLC. PLC sends message to customer and operator to intimate that car is ready for washing using GSM modem. Operator can able to control the PLC through SMS and start the process. They used four DC motors for rotating the Brushes

and two DC motors for moving the conveyor belt. A water suction motor is used to pump the water from tank and sprayed to nozzles. Two fans are used as driers. The complete hardware setup is interfaced with PLC.

Zeenal Lalluwadia *et al.* (2017) proposed his paper with the main focus on car washing system using a Delta PLC and SCADA. The car washing system proposed has three main processes namely washing, cleaning and drying; hence, the exterior of the car will be washed by detecting the car on conveyor belt and further controlled by PLC & SCADA. This system explained in this paper minimizes the use of water and also manpower requirement by using sensors and actuators to actuate its process. The SCADA system will be installed on the operator panel and hence the operator can monitor and control the whole process.

This system makes use of a conveyor system to move the car from one washing station to another. Also, proximity sensor is used to detect the presence of the car to begin each process when necessary. The system used a solenoid valve to control the flow of fluid during the washing and rinsing stage and brush to wash off dirt from the car and it used a fan to dry the vehicle. The SCADA system involved the design of the system in animation on a software platform to monitor the process in real time. This SCADA system, control and regulates the system in case of errors or abnormalities.

Raj Deepak Singh *et al.* (2018) presented this paper work an Automatic car washing using a Delta PLC. They proposed the use of a pressure cylinder to lift the car during the car wash to clean its downside. Their project was designed into a prototype model in which a car enters a washing station and automatically gets clean up. They used different components in this project such as pressure cylinder, dc motor, brushes and dryer. This system is involved the use of a conveyor belt system to move the car to the lift mechanism, where the pressure cylinder is used to lift the car upward to clean the downside. The system made use of a sprinkler system to distribute water. The use of an inductive proximity sensor was incorporated into the system to detect the presence of any nearby object by emitting electromagnetic radiation.

Patel *et al.* (2015) designed a project report stating the working operation of a working automatic car washing system with water recycling capability. They focused on the design of the water recycling system that involves the flow of used water into a plant with filtration cover designed underneath the conveyor system to control the wastage of large quantity of water. In this system, the washing components roll back and forth to wash over the vehicle. This system used high pressured foam wash to clean the dirt from the car and involved other washing stages like rinsing, waxing and drying.

Abhishek Pansare *et al.* (2015) presented this journal with the main objective to perform exterior car washing automatically using a Programmable Logic Controller integrated with the ability of sending information like arrival or departure of vehicle to the owner of the car.

This Project utilized the use of a conveyor belt on which customer stop the car. After it switch detector is used for detecting the car then conveyor belt start moving. Infrared Sensor plays a vital role on conveyor belt for car detection. As soon as car is sensed functioning on the conveyor, washing process begins with specified delay for all activities to perform before the conveyor gets to stop. The PLC made use of RSLogix 500 which is a 32-bit windows ladder logic programming package for the SLC 500 and MicroLogix processors. When each station process is completed, conveyor moves and halts at the next station for cleaning purpose which is done by brushes carried forward by sprinkling clean water. Conveyor again stops at drying section where car is dried using exhaust fan. When these processes are completed, the car would be fully washed properly.

Vasile Muresan *et al.* (2016) presented this paper with the aim of using circuits such as Atmega 328, H bridge and infrared sensors and software control like Arduino IDE for the car wash. This system is used because of its effect of not producing scratches and destroying gloss finish of the vehicle. It uses high pressure water jets without sponge and brush. The electrical installation of this system includes the use of a microcontroller ATMEGA328; optical sensor for sensing position, button to return to starting, H Bridge and engine to control a pump, motor for moving the jets of water, two pumps for water and foam washer. The optical sensor is composed of a diode infrared light and a phototransistor. IR sensor is connected to the input D5 of the microcontroller which is powered with a 5v source. To control the movement of the jet which used a DC motor, commissioned in a two-way bridge H, D2 and D3 of outputs. DC motor command is the logic outputs D9 and D10 microcontroller. The pumps are controlled by outputs D6 and D7 respectively, through transistors of the H Bridge. D4 is connected to the input button start function. Jets were introduced to wash salt which was filed under the car. Frequency converters were used for acceleration and deceleration. The IR sensors make the water jets and foam to be active only within the machine and prevent excessive consumption of water and foam for car washing.

Amir Hossein *et al.* (2013), proposed in this paper the intelligent control of full automatic car wash using a programmable logic controller (PLC) to do all steps of car washing. The Intelligent control of full automatic carwash has the ability to identify and profile the geometrical dimensions of the vehicle chassis. Vehicle dimension identification is

an important point in this control system to adjust the washing brushes position and time duration. The main purpose of the simulation is to develop criteria for designing and building this type of carwash in actual size to overcome challenges of automation. The results of this research indicated that the proposed method in process control not only increases productivity, speed, accuracy and safety but also reduce the time and cost of washing based on dynamic model of the vehicle.

This study shows washing process with a variety of simultaneous functions and control sequence that requires more than one step of the program. After a car enters and is established on a conveyor belt, various digital and analog sensors measure geometric aspects of car and sends data into the process controller to control and implement the program depending on the type of car. This stage is the stage as the criterion for entry of process. In the next step car moves on the conveyor and is washed, then it is completely dried.

Patel *et al.* (2018) presented this paper which works on automatic car washing using a PLC. The main aim of this paper is using less water and providing more efficient washing. The system made use of a pressure cylinder to lift the car to clean the car downside. Our project designed a prototype in which a car enters a washing station and automatically gets clean up.

The working of the car washing system starts when the car is entered into the washing room and the car is placed on the small conveyer. The dc motor is used in conveyer belt system. The solenoid valve is used to provide the detergent water to clean the car. This conveyer takes car to the lift mechanism. Lift mechanism lift the car upside where the brushing system and sprinkler system is used. Brushing system is used to clean the car and the sprinkler system is used to wash the car using components like proximity sensor, PLC, conveyer, solenoid valve, motor, pressure cylinder etc. The pressure cylinder is used to clean the downside of the car when it gets corrode by mud. Water is sprayed for 15sec and pump is stopped by PLC command. Then two brushes rotate and side by side soap water is also sprayed on the car for 10 sec and stops. Now the conveyor starts moving to next stage. In the next stage car is lifted by pressure cylinder where downside of the car is being cleaned. After few sec, it stops for drying. A fan is used for drying the car up to 30sec.

Amber Naik *et al.* (2015), proposed this paper to wash vehicles using a pressure washer to remove dirt. A suitable pump and motor unit is selected and along with a tank are mounted on a trolley with wheels so that the whole machine becomes portable to be carried anywhere.

The basic pressure washer consists of: A motor, such as electric, internal combustion, pneumatic or hydraulic, that drives a high pressure water pump, A high-pressure hose, A Trigger gun-style switch etc. The modeling of the trolley is carried out using SOLID EDGE ST5 from the 2D drawings, and the models are further imported for meshing of the models. The SOLID EDGE was used as the modeling software and from the 2D drawings of the trolley, the 3D model was generated. The meshing of the model was done using ANSYS 14.0 Workbench and its static structural analysis was carried out for static loadings on the trolley. They stated in their study that the pressure developed by the machine is 100 bar and it is suitable enough to clean the vehicle by removing the grease and other dirt as can be seen during demo run. The Pump runs continuously for 30 minutes. When the pump heats up it switches off automatically and it is allowed to be cooled for 15 minutes before it can be started again. The pump flow turns off when the trigger switch is released due to the presence of pressure switch inside the pump. This saves water and the pump need not be turned off by switching off the main switch while applying soap. From the analysis of trolley, the whole structure of the trolley is balanced and it can sustain the load from the tank and motor.

Seyyed SABET *et al.* (2015), presented this paper that explained the development of a new structure for a rollover car washing machine. The aim of the design was to reduce manufacturing labour, improve transportation and installation strategies and reduce weight/size.

This carwash machine structure is a portable carwash apparatus comprising an upright U-shaped piping system, which has a number of spray nozzles targeted on a central zone. The vehicle is held stationary at a designated intermediate position between rails and a travelling frame moves on the rails past the vehicle body. The travelling frame is equipped with side and top brushes to clean side and upper surfaces of the vehicle body by the rotation of brushes together with a water spray. The travelling frame is first moved in one direction so that the body is washed throughout by water, and then in reverse by the actuation of a limit switch disposed at the extremity of the rails. The car washing equipment provides an efficient washing/drying by mounting a washing water spray bar or dryer in the frame. The movement is controlled by a programmable controller or similar apparatus (such as paint spray), which is supplied with a series of sensors arranged to detect the presence and contour of the vehicle.

Muhammadali (2010) presented this seminar with the aim of explaining the working system of an automatic car washing system focus on the system water recycling capability. This system uses a conveyor, sensors for detection, brushes, nozzles etc. This system utilizes a water recycling system that comprises of a filtration to reduce water wastage. The

mechanism inputs the wash PLC into the master computer automatically. After the car pulls up to the tunnel entrance, an attendant usually guides the customer onto the track or conveyor. At some washes, both tires will pass over a tire sensor, and the system will send several rollers. The tire sensor lets the wash system know where the wheels are and how far apart they are. The rollers come up behind the tires, pushing the car through a detector, which measures vehicle length, allowing the controller to tailor the wash to each individual vehicle. The next arch will often be wraparounds, usually made of a soft cloth, or closed cell foam material to wash the dirt off the car and then rinsing action takes place at the next arch leading to the final stage which dries the car using an exhaust fan.

Bambare Tejas *et al.*, (2012) presented this paper with the main aim of using electromechanical means to lift the vehicle during the car was system. This paper explains about the use of electro-mechanical system for controlling automatic car washer. The mechanism for automatic car washer includes lifting of parallel vehicles and moving in forward direction. Then washing of vehicles takes place firstly with foam water then with soap water and again with clean water. Finally vehicle is lifted again and placed back parallel. The DC motor lifts the car pallet in upward direction. Thus, this is the lifting mechanism. After lifting the horizontal travel of the pallet starts. This movement is done by another dc motor. Immediate after lifting, the clean water supply is started and then the trolley movement. i.e. travel starts, and then at another stage, the soap water is allowed to fall on the car. After the specified time this soap water stops and again the clean water is allowed to fall on the car. After specified time as above, the different types of waters different water tanks with electric motor pumps are provided.

After passing through different types of cleaning waters, the car is dried in a separate chamber and then the horizontal motor stops and the vertical lifting motors starts and rotates in opposite direction than the first movement. Then, the horizontal parallel moves in back word direction and the pallet comes at its original position, from where the next car can be loaded for other washing process.



CHAPTER THREE

METHODOLOGY

3.1 DESIGN DESCRIPTION

The automatic car washing system is a system that is built basically to wash the exterior of a car efficiently without damaging the paint finish of a car and in the process reducing water waste by recycling process.

The system consist of a control panel where all electrical components like a power supply, PLC, VFD, Relay, Circuit breaker, contactor are boxed in. Also, the system involves the use of a belt conveyor system to move the car from one station to another which is connected to an AC motor with a chain. It has different stations which have AC motor to drive the brushes, exhaust fan for drying and a pipelining system for the flow of liquid.

3.2 DESIGN CONSIDERATION

In the design of the automatic car washing system, these steps must be followed:

- i. Design of the system
- ii. Design analysis calculation
- iii. Choice of electric motor
- iv. Programming of system
- v. Design of recycling system
- vi. Design of electrical connection

Factors to be considered in the design of the system are:

- i. Efficiency
- ii. Source of energy
- iii. Rigidity and strength of frame
- iv. Ease of manufacture and subsequent maintenance
- v. Cost of production

3.3 PARTS OF THE MACHINE AND ITS FUNCTIONS:

- i. Conveyor belt system: This is responsible for moving the car from one station to another for various washing process.
- ii. Electrical control panel: This compartment houses all the electrical components required to make the system function. It is responsible for indicating the status of the washing process using LED indicator and controlling the process using several push buttons.
- iii. Electric motor: This is the prime mover for the machine which turns the chain resulting to the movement on the conveyor system.
- iv. Frame: This supports the machine and it provides a framework to house the entire washing system.

3.4 OPERATING PRINCIPLE

The automatic car washing system runs on electrical energy, once the electric motor is connected to the source of electric power it turns the chains connected from the motor to the roller of conveyor belt which in turn moves the belt of the conveying system to transport the car from one washing station to another performing its process.

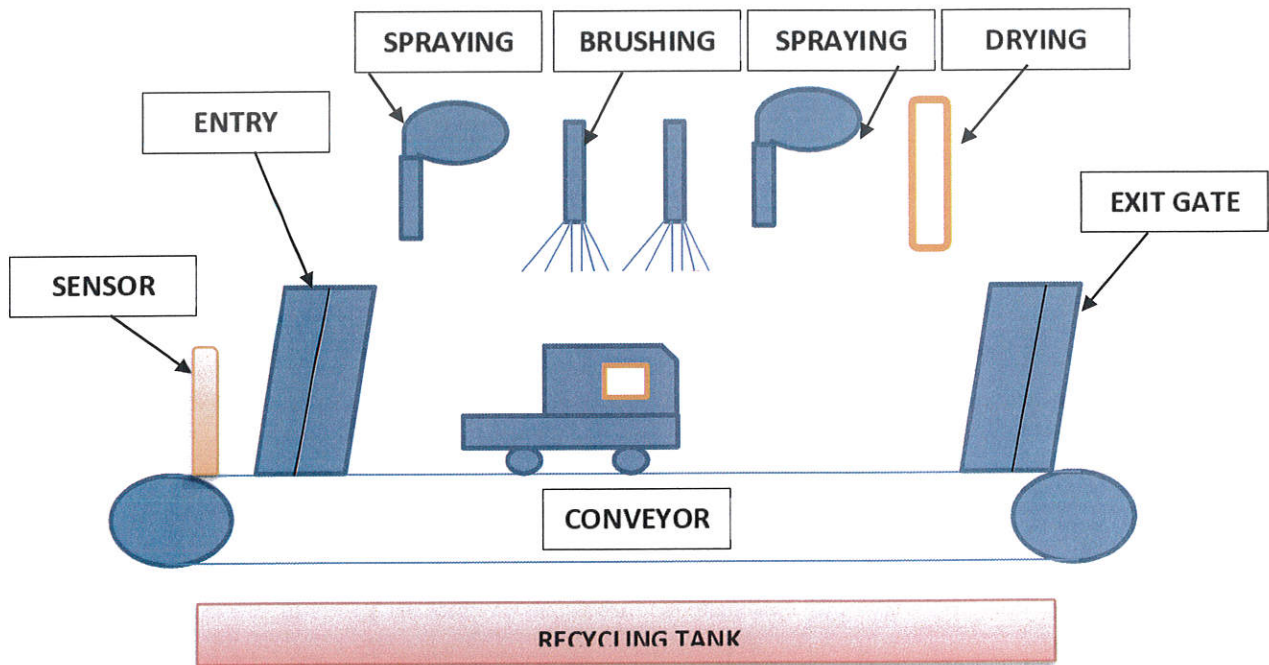

Figure 3.1: Schematic diagram of a working automatic car washing system

3.5 WORKING PRINCIPLE

The design of the system can be divided into several parts:

1. Conveyor Belt Mechanism:

It presents a continually moving surface that is designed to move objects from one location to another. Different types of conveying machine are available regarding principle of operation, means and direction of conveyance, like vibrating screw conveyors, pneumatic conveyors and the moving floor system. The one we used is belt conveyor system. It consists of a rubber belt, chain and AC motor. The belt forms a continuous loop and is supported either on rollers, for heavy loads, or on a metal slider pan when the load is light enough to prevent frictional drag on the belt. Electric motors operating through constant- or variable-speed reduction gears usually provide the power.

2. Car Detection Mechanism

The task of car detection is performed using an inductive sensor. An inductive sensor is placed on the side of the conveyor belt at the different washing station to detect the presence of the car. The main component of a inductive detector is an oscillator whose capacitors form the sensitive surface. When a conductive or insulating material with a permittivity > 1 is placed in this field, it modifies the coupling inductance and causes oscillations.

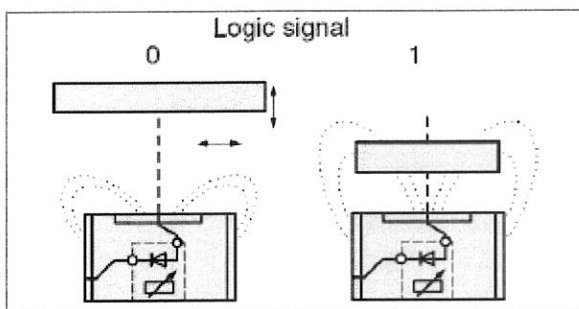

Figure 3.2: Inductive sensing

When a car is brought in front of the sensor by the conveyor belt, the infrared light emitted from the emitter does not get reflected back hence the receiver does not receive any signal. Based on these two conditions the PLC will give command to the conveyor motor to run or to stop.

3. Liquid Flow Control Mechanism from Reservoir to the spraying station

When the car is detected by the inductive sensor, the task of washing or rinsing the car with liquid starts. A solenoid pump is used to pump the liquid from the reservoir to the needing station through a pipe. The pipe is passed over the station and cut appropriately at the station to where the liquid will fall on the car to perform its washing process. When a car stops underneath the pipe, it gets a command from the PLC to open the flow of liquid flow from the reservoir to the car.

4. Liquid flow control mechanism from the washing station to the filtering unit.

During the washing process of the car, liquid flows from the reservoir to the washing station and the liquid flows on the conveyor belt to the filtering station tank designed underneath the conveyor belt. This tank is designed with a filter above it to separate dirt in the liquid solution from the car wash station to the filtered tank station. When the liquid is filtered from the dirt, the solenoid pump transfers the liquid back to the reservoir tank.

3.6 BLOCK DIAGRAM OF SYSTEM

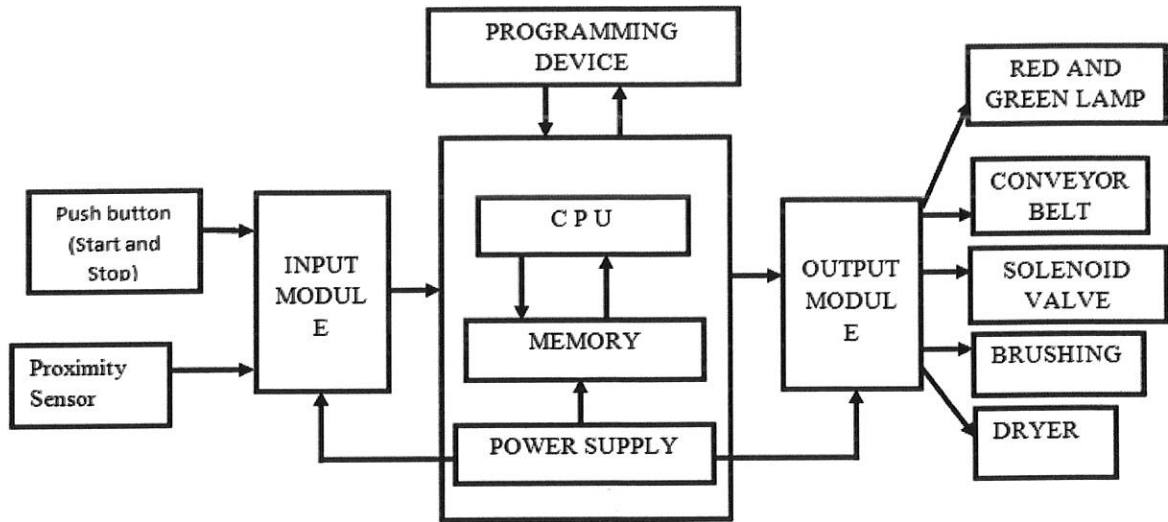

Figure 3.3: Block Diagram of the system

3.7 WORKING PROCEDURE

ENTRY/ INPUT SECTION

At the entry stage, when the car is parked on the conveyor track, release all brakes, and refrain from steering (failure to do so can cause an accident on the conveyor).

The inductive proximity sensor detects the presence of the car and energizes the conveyor by activating the AC motor for driving the conveyor to roll to move the car place on the conveyor belt into the washing tunnel automatically and stops at the stage of washing when the second proximity sensor at the pre-wash stage detects the presence of the car.

PRE WASH SECTION

At this section, flow of soap liquid via a pipelining system is placed directly underneath the car for few sec as the conveyor moves slowly and the piping system closes when the car reaches the next station. Now the conveyor starts moving to next stage (brushing stage).

BRUSHING SECTION

At the brushing stage, the proximity sensor detects the presence of the car and energizes the dc motor to activate the brushes. A set of horizontal brushes wash the side of the car. Two sets of side brush wash the area around the vehicles. After a few seconds, it stops when the car leaves the station. Cloth is used instead of hard brush for making a gentle clean of the car it does not harm any painted finish and provides a gentle polishing effect to leave the paint much shinier. Now the conveyor starts moving to next stage for final washing.

FINAL WASH SECTION (RINSE)

At the final washing stage, a piping system is placed at a position directly underneath the car for spraying clean water to rinse the car after the brushing section. The water spread round all the body of the car and left no traces of unclean spot on the car body. The pipe is turned off when the car leaves the station for the next station. Then the conveyor starts moving the car to the drying section.

DRYING/ EXIT SECTION

At the drying stage, car is sensed by the inductive proximity sensor and so the conveyor belt stop and dryer/fans is turns on. A hot air is made to be touched over the car for making the car to become dry. Hence the car will be dried using the dryers. After this stage the car is cleaned and then the conveyor carrying car moves to the exit level.

After the drying section, the system sends an input signal to Programmable logic controller and this energize the green lamp (indicator) that the car is cleaned and the tunnel is ready for another wash.

3.8 HARDWARE COMPONENTS OF THE SYSTEM

Hardware components of the system and description

Table 1: System Components of the Automatic Car Washing System

S/N	SYSTEM COMPONENT	QTY	MODEL/ VERSION	REASON FOR USE
1	PLC	1	Logo Zelio	For monitoring and control of speed of motor
2	Proximity sensor	3	Inductive	It is used to sense the presence of the metallic car
3	AC motor	1	Water resistant	It is used to move the conveyor belt
4	Universal motor	2	-	It is used to rotate the brushes for the brushing section
5	Dryer exhaust fan	2	Snuon	It is used to dry the washed car
6	Pump	3	Solenoid	It is used to pump water from the reservoir tank to the necessary washing section
7	Relay	5	Omron	It is used to control the sensors for the PLC
8	Contactator	1	Schneider	It is used to switch large current
9	Circuit breaker	1	Nadar	It is used to the control the flow of electric current into the control panel section
10	Push button	3	-	It is used to control the operations of the -system
11	LED	3	-	It is used to indicate the working status of the system
12	Power supply	1	Hengfu	It is used to convert 220v to 24v for the PLC
13	Variable frequency drive (VFD)	1	Omron Vs mini J7	It is used to control the speed of the motor by reducing the frequency

14	Pipe hose	3	Rubber	It is used to transport water from one station to another
15	Conveyor belt	1	Rubber	It is used to move the car from one washing station to the next.
16	Terminal block	1	-	It is used to transfer 24v from power supply to other components needing power.
17	Reservoir	1	Metallic	It is used to store water for the washing process.

3.9 COMPONENTS OVERVIEW

1. ZELIO PLC (SR3B261BD)

Zelio Programmable Logic Controller (PLC) is a special form of microprocessor-based controller that uses programmable memory to store instructions and to implement functions such as on/off control, sequencing, timing, counting, and arithmetic in order to control machines and processes. Check Appendix A for datasheet of the PLC.

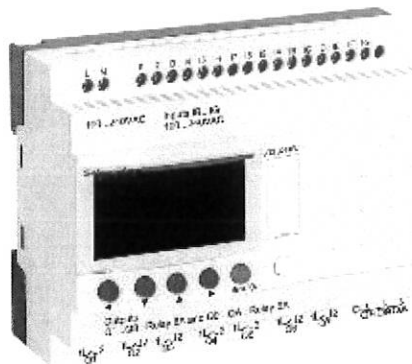

Figure 3.4: Zelio PLC

2. MOTOR

A motor is an electrical machine that can transform an electrical energy into a mechanical one (**motor mode**) or transform a mechanical energy into an electrical one (**generator**)

mode). Two types of motors are used in this project. First is an AC motor and second is a universal motor

AC MOTOR

An AC motor is an electric motor driven by an alternating current (AC). The AC motor commonly consists of two basic parts, an outside stator having coils supplied with alternating current to produce a rotating magnetic field, and an inside rotor attached to the output shaft producing a second rotating magnetic field. The rotor magnetic field may be produced by permanent magnets, reluctance saliency, or DC or AC electrical windings.

UNIVERSAL MOTOR

A universal motor is a design that can operate on either AC or DC power. In universal motors the stator and rotor of a brushed DC motor are both wound and supplied from an external source, with the torque being a function of the rotor current times the stator current so reversing the current in both rotor and stator does not reverse the rotation. Universal motors can run on AC as well as DC provided the frequency is not so high that the inductive reactance of the stator winding and eddy current losses become problems. Nearly all universal motors are series-wound because their stators have relatively few turns, minimizing inductance. Universal motors are compact, have high starting torque and can be varied in speed over a wide range with relatively simple controls such as rheostats and PWM choppers. Compared with induction motors, universal motors do have some drawbacks inherent to their brushes and commutators: relatively high levels of electrical and acoustic noise, low reliability and more frequent required maintenance.



Figure 3.5: Universal AC Motor

OPERATING PRINCIPLE

The two main types of AC motors are induction motors and synchronous motors. The induction motor (or asynchronous motor) always relies on a small difference in speed between the stator rotating magnetic field and the rotor shaft speed called slip to induce rotor current in the rotor AC winding. As a result, the induction motor cannot produce torque near synchronous speed where induction (or slip) is irrelevant or ceases to exist. In contrast, the synchronous motor does not rely on slip-induction for operation and uses either permanent magnets, salient poles (having projecting magnetic poles), or an independently excited rotor winding. The synchronous motor produces its rated torque at exactly synchronous speed.

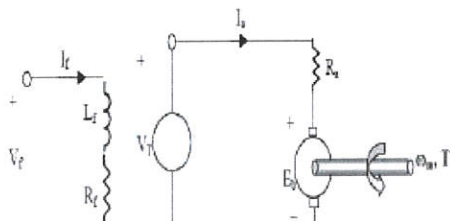

Figure 3.66: Equivalent Circuit of Motor

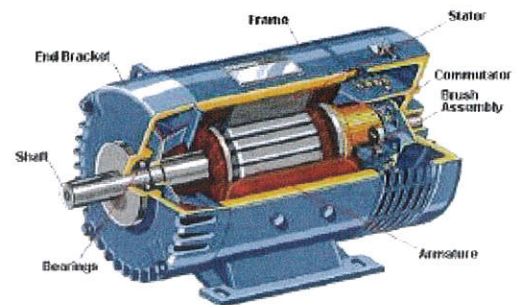

Figure 3.77: Motor components

3. INDUCTIVE SENSOR

Inductive sensors belong to a category of non-contact sensor. It is used for positioning and detection of metal objects. The sensing range of an inductive switch is dependent on the type of metal being detected. Ferrous metals such as iron and steel, allow for longer sensing range, while nonferrous metals, such as aluminum and copper, may reduce the sensing range by up to 60 percent. The sensor consists of an induction loop or detector coil. Most often this is physically a number of turns of insulated magnet wire wound around a high magnetic permeability core, such as ferrite ceramic rod and the winding may or may not have a feedback tap some number of turns from one end of the total winding. It is connected to a capacitance to form a tuned frequency oscillator tank circuit. When power is applied, the resulting oscillation is a high frequency alternating electric current in the coil that has a constantly changing magnetic field able to induce eddy currents in proximal conductors. The closer the target is the greater the conductivity.

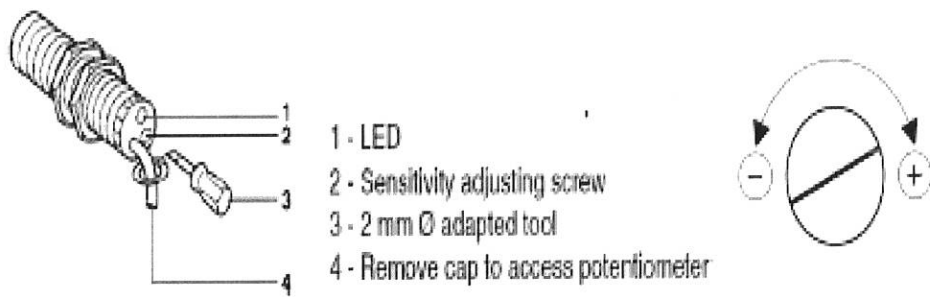

Figure 3.8: Inductive sensor

4. DRYER EXHAUST FAN:

This is used to produce cool air, when the power coil of the fan is energized resulting to the rotation of the curved plastic blades in a clockwise rotation.

Fan Description:

1. Rated Voltage: 5V- 12V- 24V
2. Operation Voltage: 3.5-27.6V
3. Rated Current: 0.08-0.45A
4. Rated Speed:3000-5000RPM
5. Air Flow: 23.72-51.23CFM
6. Static Pressure:3.1-9.63H2O
7. Noise Level: 24.84-45.32dBA
8. Weight: 63g

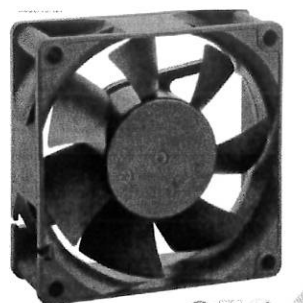

Figure 3.9: Dryer Exhaust fan

5. RELAY

A relay is an electrically operated switch. Relays are used where it is necessary to control a circuit by a separate low-power signal, or where several circuits must be controlled by one signal. The operating voltages and currents of our actuators (electro valve, pump, and DC gear motor) are different than the outputs of the PLC so Relays are used to make the output of the PLC drive the actuators through external power circuit. A relay is an electromagnetic switch operated by a relatively small electric current that can turn ON or OFF a much larger electric current. The heart of a relay is an electromagnet (a coil of wire that becomes a

temporary magnet when electricity flows through it). Relays are used where it is necessary to control a circuit by a different signal with complete electrical isolation between control and controlled circuits.

G2R-1-E Omron relays are used in this project which has the following specifications:

- **Description:** General purpose power relay.
- **Rated coil voltage:** 24VDC / 110VAC.
- **Rated switching current:** 16A at 250VAC / 16A at 30VDC.

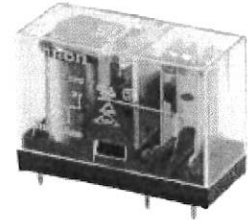

Figure 3.10: Omron Relay

6. CONTACTOR

A contactor is an electrically-controlled switch used for switching an electrical power circuit. A contactor is typically controlled by a circuit, which has a much lower power level than the switched circuit, such as a 24-volt coil electromagnet controlling a 230-volt motor switch.

Unlike general-purpose relays, contactors are designed to be directly connected to high-current load devices. Relays tend to be of lower capacity and are usually designed for both *normally closed* and *normally open* applications. Devices switching more than 15 amperes or in circuits rated more than a few kilowatts are usually called contactors. Contactors are designed with features to control and suppress the arc produced when interrupting heavy motor currents.

OPERATING PRINCIPLE

When current passes through the electromagnet, a magnetic field is produced; this attracts the moving core of the contactor. The electromagnet coil draws more current initially, until its inductance increases when the metal core enters the coil. The moving contact is propelled by the moving core; the force developed by the electromagnet holds the moving and fixed contacts together. When the contactor coil is de-energized, gravity or a spring returns the electromagnet core to its initial position and opens the contacts.

For contactors energized with alternating current, a small part of the core is surrounded with a shading coil, which slightly delays the magnetic flux in the core. The effect is to average out

the alternating pull of the magnetic field and so prevent the core from buzzing at twice line frequency.-

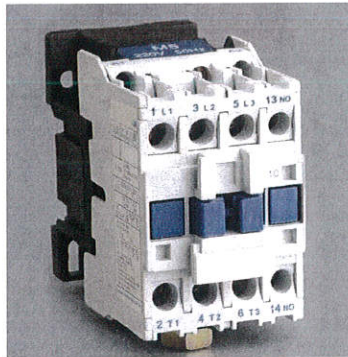

Figure 3.11: Contactor

7. CIRCUIT BREAKER

A circuit breaker is an automatically operated electrical switch designed to protect an electrical circuit from damage caused by excess current from an overload or short circuit. Its basic function is to interrupt current flow after a fault is detected. Unlike a fuse, which operates once and then must be replaced, a circuit breaker can be reset (either manually or automatically) to resume normal operation.

OPERATING PRINCIPLE

The circuit breaker must first detect a fault condition. In small mains and low voltage circuit breakers, this is usually done within the device itself. Typically, the heating or magnetic effects of electric current are employed. Circuit breakers for large currents or high voltages are usually arranged with protective relay pilot devices to sense a fault condition and to operate the opening mechanism.

Once a fault is detected, the circuit breaker contacts must open to interrupt the circuit; this is commonly done using mechanically stored energy contained within the breaker, such as a spring or compressed air to separate the contacts. Circuit breakers may also use the higher current caused by the fault to separate the contacts, such as thermal expansion or a magnetic field. Small circuit breakers typically have a manual control lever to switch off the load or reset a tripped breaker, while larger units use solenoids to trip the mechanism, and electric motors to restore energy to the springs.



Figure 3.12: Circuit breaker

8. POWER SUPPLY

This is an electrical device that supplies electric power to an electric load. It converts electric current from a source to the correct voltage, current and frequency to power the load. DC power supply uses AC mains electricity as an energy source. This power supply employs a transformer to convert the input voltage to a lower AC voltage; a rectifier is used to convert the transformer output voltage to a varying DC voltage, which in turn is passed through an electronic filter to convert it to an unregulated DC voltage.



Figure 3.13: Power Supply

9. VARIABLE FREQUENCY DRIVE (VFD):

VFD is variable frequency drive. VFD can also refer as variable speed drive, adjustable speed drive, adjustable frequency drive, AC drive, micro drive and inverter. It is a system which gets used to control the speed of electric motor by controlling the frequency and voltage. Frequency is directly proportional to the speed of electric motor. By adjusting the frequency, speed can be varied according to requirements or applications. VFD makes the process reliable and output variable is easily controlled.

WORKING PRINCIPLE OF VARIABLE FREQUENCY DRIVE:

A variable frequency drive converts incoming 50 Hz power into DC, then converts to a variable voltage, variable frequency output.

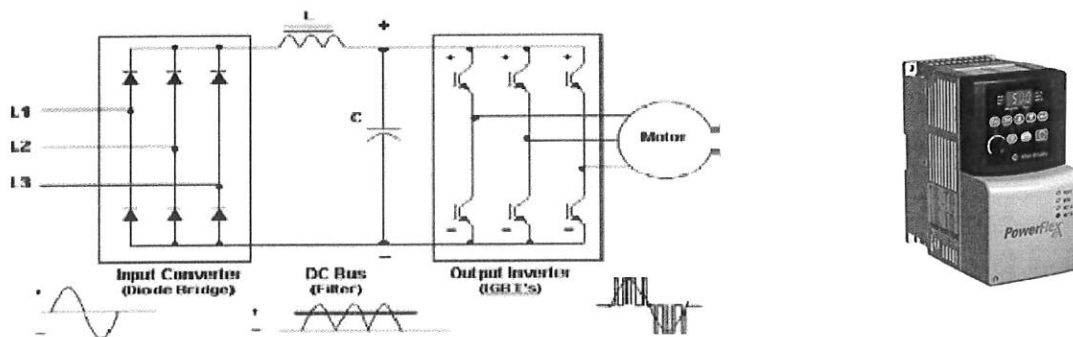

Figure 3.14: Variable Frequency Drive

In the block diagram of variable frequency drive figure mentioned. The block diagram of variable frequency drive shows that VFD has three stages as input converter, DC bus, and Output inverter. Input converter is consisting of Diode Bridge. Dc bus consists of inductor and capacitor. Output converters consist of IGBT. Output inverter is connected to motor.

The working of three stages of VFD is as follows:

CONVERTER:

The first stage of motor controller or VFD is converter. Converter is made up of six diodes. Three phase voltage is directly supplied to the converter. Converter allows the current to flow only in one direction. If one of the phase voltages from L1, L2, L3 is greater than another two phase voltages then diode connected to that phase voltage get turnon and same principal get

used at negative side of diode. At the output six current pulses occurs, so it is also called as 6 pulses VFD. 6 pulse.

DC BUS:

The second stage of VFD is DC bus. The basic principal of DC bus is to remove ripples. The DC bus is the link between converter and inverter. At the output of rectifier circuit we get dc signal. The output of rectifiers contains large number of ripples so dc bus removes ripples from output. It also provides protection for the drive. At the output of DC bus ripple free Dc is present.

INVERTER:

The last stage of VFD is inverter. Inverter is made up of transistors. Transistors work as switches. If one of switch from top get closed then phase of electric motor get connected to positive DC bus and voltage on that phase becomes positive. Same principal get used for the switches at bottom and for these bottom switches phase get negative DC bus and voltage on that phase become negative. By turning on switches in any order, the phase and the rotation of electric motor can be changed. So making phase voltage positive, negative or zero, variable frequency gets at the output. As frequency is directly proportional to the speed of motor and motor speed get varied according to requirement or applications. So Inverter is a unit where filtered DC supply is being converted to AC Supply which is supply to the electric motor connected to it.

10. DC motor pump

A solenoid pump is a form of positive displacement pump which uses a diaphragm and solenoid assembly to displace the fluid into discharge line. It is a DC motor which has pump assembly attached to it to pump liquids as shown.

It is used to pump the liquid from the main reservoir to the overhead tank. The motor used in this pump is rated 12V DC and draws up to 3 A current this amount of current cannot be supplied by the PLC therefore an external power circuit is required.

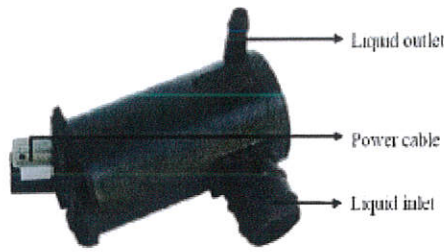
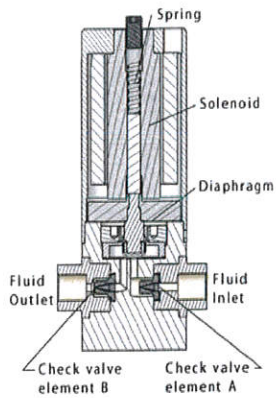

Figure 3.15: DC Pump

11. RESERVOIR

Main reservoir

A rectangular metal container is used as a main reservoir in our project. It is situated underneath the conveyor belt. It has a DC motor pump attached to it. The DC motor pump extracts liquid from main reservoir to the washing station through pipelining system.

Filter reservoir

A rectangular metal container is used a reservoir for filtered liquid in our project. It is situated underneath the conveyor belt. It has a DC motor pump attached to it. The DC motor pump extracts liquid from the filter tank to the main reservoir through pipelining system.

12. PUSH BUTTONS

A push-button is a simple switch mechanism for controlling some aspect of a machine or a process. Buttons are typically made out of hard material, usually plastic or metal. The surface is usually flat or shaped to accommodate the human finger or hand, so as to be easily depressed or pushed. Buttons are most often biased switches, although many un-biased buttons (due to their physical nature) still require a spring to return to their un-pushed state.



Figure 3.16: Push button

13. LED INDICATOR

LEDs operate by electroluminescence, a phenomenon in which the emission of photons is caused by electronic excitation of a material. The material used most often in LEDs is gallium arsenide, though there are many variations on this basic compound, such as aluminum gallium arsenide or aluminum gallium indium phosphide. By varying the precise composition of the semiconductor, the wavelength (and therefore the colour) of the emitted light can be changed. LED emission is generally in the visible part of the spectrum (i.e., with wavelengths from 0.4 to 0.7 micrometre) or in the near infrared (with wavelengths between 0.7 and 2.0 micrometres). The brightness of the light observed from an LED depends on the power emitted by the LED and on the relative sensitivity of the eye at the emitted wavelength.



Figure 3.17: LED

14. TERMINAL BLOCK

A screw terminal is a type of electrical connector where a wire is held by the tightening of a screw. The wire may be wrapped directly under the head of a screw, may be held by a metal plate forced against the wire by a screw, or may be held by what is, in effect, a set screw in the side of a metal tube. The wire may be directly stripped of insulation and inserted under the head of a screw or into the terminal. Otherwise, it may be either inserted first into a ferrule, which is then inserted into the terminal, or else attached to a connecting lug which is then fixed under the screw head.

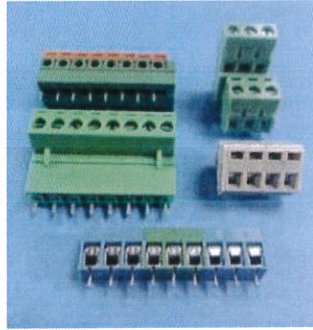

Figure 3.18: Terminal block

15. CONVEYOR BELT

A conveyor system is a common piece of mechanical handling equipment that moves materials from one location to another. Conveyors are especially useful in applications involving the transportation of heavy or bulky materials. Conveyor systems allow quick and efficient transportation for a wide variety of materials.

Specifications: -

- Length: 1.8 meter
- Width: 0.2 meter
- Material: Rubber
- Sections:
 - ✓ Prewash : 0.3 meter
 - ✓ Brushing : 0.3 meter
 - ✓ Drying & Exit : 0.3 meter



Figure 3.19: Conveyor belt

16. WATER TANK:

A water tank is a container for storing water. The Water tank we used is made of metal and divided into various compartments for clean water, soapy water and recycled water. The water tank is of the capacity of 2 liters. This water will be used by the pump to spray it via a piping system. An outlet hole is drilled to the tank to which a tank nipple is placed.

17. WATER PIPES

A pipe is a rigid hollow tube designed to carry fluids from one location to another. The shape of a pipe is usually cylindrical. Pipe design is based on a combination of application and performance. Common factors are size, pressure rating, weight, length, straight pipe or Coil pipe and Chemical Compatibility. To take the water from the pump to the area of application a pipe is required. The pipe should sustain the pressure produced inside it by the action of pump and the nozzle. The pipe used is of 5 mm diameter. It is connected to the outlet of the pipe and its other end to the pump.

18. CLOTH BRUSH

The brush is composed of natural or synthetic fibres set into a handle that is used for cleaning and absorbing dirt's.



Figure 3.20: Cloth brush

3.10 INPUT AND OUTPUT ADDRESSING

Table 2: INPUT ADDRESSING

S/N	INPUT	ADDRESS	TAG NO
1	Start Push button	I 0.1	Activate the operation
2	Stop push button	I 0.2	Stop the operation
3	Inductive sensor 1	I 0.3	Inductive sensor for brushing
4	Inductive sensor 2	I 0.4	Inductive sensor for rinsing
5	Inductive sensor 3	I 0.5	Inductive sensor for drying

Table 3: OUTPUT ADDRESSING

S/N	OUTPUT	ADDRESS	TAG NO
1	Green LED	Q 4.0	Indicate washing process
2	Motor	Q 4.1	Energize the conveyor
3	Yellow LED	Q 4.2	Energize the conveyor light
4	Brush	Q 4.3	Activate the brush
5	Pump 1	Q 4.4	Activate the pump
6	Pump 2	Q 4.5	Energize the rinse water
7	Fan	Q 4.6	Activate the dryer and exit section
8	Pump 3	Q 4.7	Recycling pump

Machines and Equipment used in the manufacturing process:

- i. Electric Arc Welding machine
- ii. Drilling machine
- iii. Screw driver
- iv. Measuring tape
- v. Hammer
- vi. Power saw
- vii. Cutting disc
- viii. Grinding disc

3.11 CONCEPT OF VFD TO CONTROL MOTOR SPEED

In electric motor, voltage induced in the stator of electric motor is directly proportional to the frequency and air gap flux. If we reduce the frequency keeping voltage constant then there is increase in air gap flux. This is undesirable effect. So to vary speed we must keep V/F ratio constant. V/F method uses the technique in which several motors can be connected to the single VFD. V/F control techniques has advantages like low starting current and have wide range of speed. V/F control method does not used where precise speed regulation operator is required.

In our design, the frequency specification of the motor used is 60Hz, but the frequency was reduced to 14Hz with the use of a VFD by tuning the frequency down. The tuned frequency of 14Hz enables the electric motor to rotate slowly producing little torque and reducing the speed.

3.12 SYSTEM IMPLEMENTATION

3.12.1 MECHANICAL DESIGN AND IMPLEMENTATION

Firstly, the design of the system is modeled using AutoCAD software and aluminum is used to fabricate the framework of the system on which the project stands on. The framework is constructed by cutting the aluminum into several parts according to the design specification using components like hack saw, electric arc welding machine etc. The electric motor is bolted unto the frame at the lower position of frame, two rollers are installed at both ends and the belt is joined on both rollers. The tension of the belt is adjusted at the pulley to ensure the smooth running of the belt. A recycling system is incorporated into this design with the use of a net filter which is used to remove dirt or particles. A reservoir tank is put underneath the system where used water is collected after been filtered from dirt. A pump is put in this reservoir tank to pump back the used water into the soap tank. A transparent plastic is installed unto the platform to see the working processes of the system and several electrical components like the sensors and fan and fixed on the plastic.

3.12.2 ELECTRICAL CIRCUIT DESIGN AND IMPLEMENTATION

In the electrical system, a 220v is used as source power and is connected to a Miniature Current Circuit Breaker (MCCB) which is used to control electrical power efficiently. MCCB transfers power from a source to the power supply. The power supply converts the 220v to a 24v power which enters the PLC (programmable logical controller) which is the brain of the system that controls the entire system operation. There are multiple arrangements of inputs and outputs in PLC which can be digital or analog. Several inputs and outputs are connected to the PLC at different terminals and addresses.

In this design, we used an A.C. motor to roll the conveyor belt for moving the vehicle on the conveyor belt to each washing process The speed of A.C. motor used in this project is

controlled using a variable frequency drive (VFD) from a 60Hz to a 14Hz. The motor is powered by 220v from the source power. The 24v from the power supply is connected to a terminal block to power other components like the control panel, pump, relays and other sensors.

Check Appendix for the circuit diagram.

3.12.3 CONTROL PANEL

The Control Operator Panel or Terminal is the input-output device through which the human operator controls, monitors the process, which in the form of push buttons. The control panel is powered by 24v from the terminal block. The control panel use external push buttons to control the system namely: Green button for starting the operation, small Red button to end operation and the large red button for Emergency Stop. The control panel uses three LED to indicate different status of the operation. The GREEN LED is to show the system is ON, the AMBER LED is to show the washing process in activated and the RED LED is to show he stop of the system.

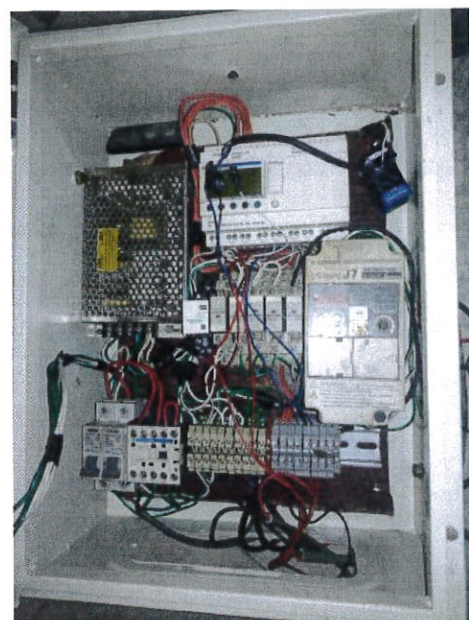
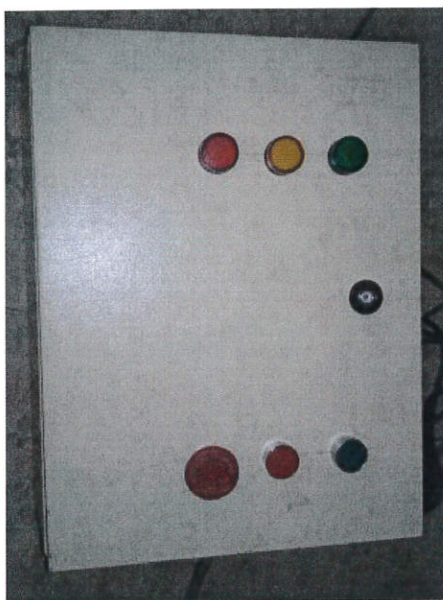



Figure 3.21: Control Panel

3.12.4 CONTROL SECTION AND IMPLEMENTATION CODING: LADDER LOGIC PROGRAMMING

The process control application was conducted via online programming on the Zelio Logo PLC. A visual programming language known as the ladder logic is used to program the PLC. This Online Programming mode involves inputting the ladder logic programs via buttons on the PLC and each rung of program is downloaded immediately to the PLC memory. The Zelio PLC is used because of its high reliability feature in comparison with relays, and also its ability to control all system functions; including starting point, stop, monitor, etc. are used. In this process, Zelio PLC, which in addition to the basic logic control, has the possibility of using continuous control, analog processing and it provides communication between them. The detection of vehicle by proximity sensors is carried out and data is sent to I/O function PLC uses these data to adjust functional program of the device and carried out the necessary function. Check Appendix for ladder logic program.

3.13 PROGRAMMING FLOWCHART

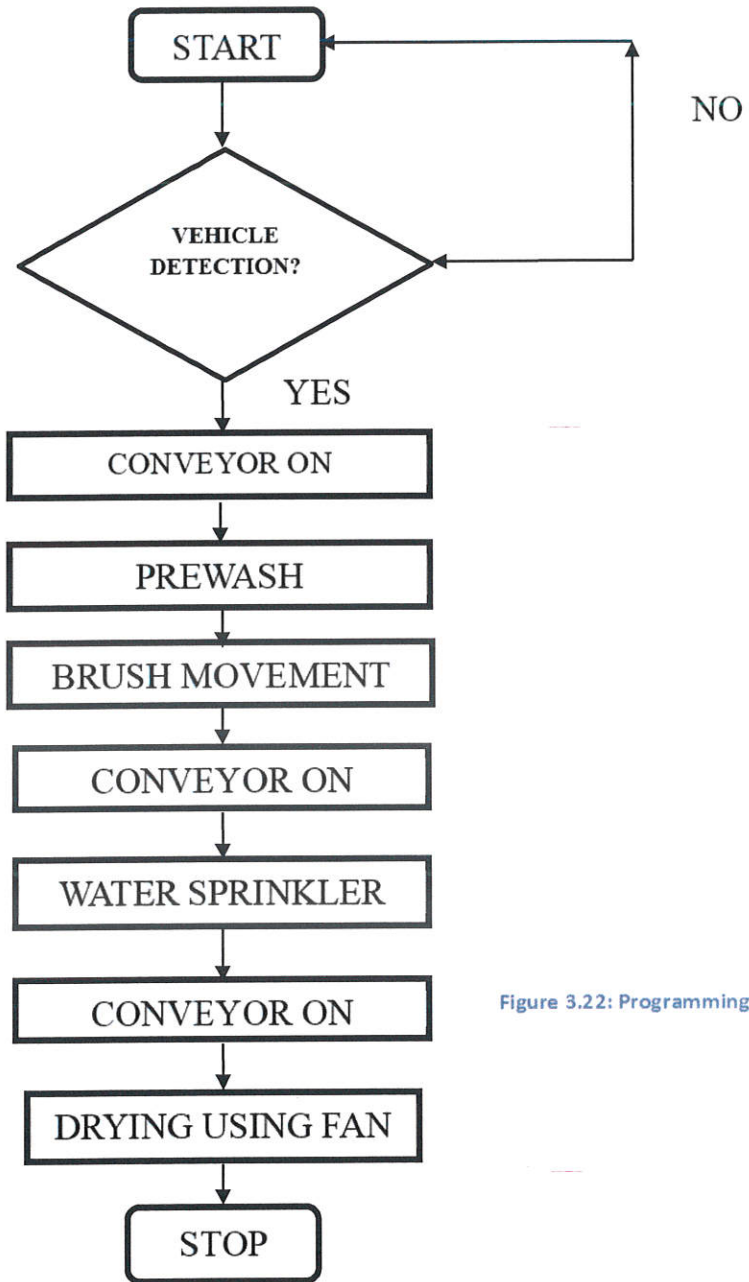

Figure 3.22: Programming Flowchart

3.14 DESIGN CALCULATION FOR CONVEYOR

Motor power = 5.0kw

Synchronous speed (motor rpm) = 1400rpm (medium)

Belt width (m) = 7.7cm = 0.077m

Length of a conveyer = 106cm = 1.06m

Conveyor Belt Length = 93cm = 0.93m

Basic belt length = 2 x conveyor belt length

$$= 2 \times 93 = 1.86\text{m}$$

Roller diameter = 40mm = 0.04m

Belt speed = $v = \pi \times \text{Diameter}$

$$\pi \times 0.04 = 0.12\text{m/s}$$

$$\text{CONVEYOR CAPACITY} = C = \frac{C_T \times P \times C_F \times V}{1000}$$

Where C: Capacity in tonnes/hr of a belt conveyor consisting of 3 equal roller idlers.

C_T : The Capacity of troughed belts for 3 roll length idler = 175

P is the material density in $\text{kg/m}^3 = 100\text{kg/m}^3$

C_F : Capacity Factor = 1.0

V = Belt speed = 0.12m/s

$$\text{Conveyor capacity} = C = \frac{175 \times 1000 \times 1 \times 0.12}{1000} = 21 \text{ tonnes/hr}$$

***The conveyor consisting of 3 equal rollers idlers is 21 tonnes/hr

LOAD DUE TO CONVEYED MATERIALS MM:

Conveyor capacity (C) = 21 tonnes/hr

V = belt speed = 0.12m/s

$$m_m = \frac{C}{3.6 \times v}$$

$$m_m = \frac{21}{3.6 \times 0.12} = 48.61kg$$

TORQUE CALCULATION

$$Torque (T) = \frac{1}{2}D(F + \mu Wg)$$

Where D = Roller diameter = 0.04m

F = m x g

M = weight of the material and belt = 25kg

G = 9.81m/s²

F = 25 x 9.81 = 245.25N

W = weight of the material = 12kg

μ = coefficient of friction = 0.02

$$Torque (T) = \frac{1}{2} \times 0.04 [245.25 + (0.02 \times 12 \times 9.810)]$$

Torque = 4.95Nm

BELT TENSION:

Belt tension at steady tension (T_{ss})

$$(T_{ss}) = 1.37 \times f \times l \times g \times (2 \times M_i + (2 \times M_b + M_m) \cos(\theta)) + (H \times g \times M_m)$$

Given:

F: coefficient of friction = 0.02

L: Length of conveyor belt = 0.93m

G: acceleration due to gravity = 9.81m/s^2

M_i: Load due to the idlers = 12kg

M_b: Load due to belt: 25kg/m

M_m: Load due to conveyed materials = 48.6kg

θ : Angle of inclination of the conveyor = 0

H: Vertical height of the conveyor = 0.26m

Idler spacing = 1.2m

ASSUMPTION:

$$M_i: \text{Load due to idlers} = \frac{\text{Mass of a set of iflers}}{\text{idler spacing}} = \frac{14.4\text{kg}}{1.2} = 12\text{kg}$$

M_b: Load due to belt: 25kg/m

Mass of a set of idler = 14.4kg

$$(T_{ss}) = 1.37 \times 0.02 \times 0.93 \times 9.81 [2 \times 12 + (2 \times 25 + 48.6) \cos(0^0)] + [0.26 \times 9.81 \times 48.6]$$

$$= 30.6474 + 123.96$$

$$= 154.6\text{kN}$$

Idler spacing = 1.2m (For standard 3 idler rollers of equivalent length, the most recognized trough point is 350. So $C_T = 350/2 = 175$ is used)

During the start of the conveyor system, the tension in the belt will be much higher than the steady state.

The belt tension while starting is:

$$T_s = T_{SS} \times K_s$$

$K_s =$ Start up factor (1.08)

$$\begin{aligned} T_s &= 154.6 \times 1.08 \\ &= 166.97\text{kN}. \end{aligned}$$

BELT POWER

The power at the drive pulley is

$$P_p = \frac{T_{SS} \times v}{1000} = \frac{154.6 \times 0.12}{1000}$$

$$= 0.17\text{kW}$$

$$\text{Minimum power (P}_{\min}) = \frac{P_p}{n}$$

$n =$ Drive efficiency = 0.05

$$\text{Minimum power (P}_{\min}) = \frac{0.17}{0.05} = 3.4\text{kW}$$

$$\text{Belt width (m)} = 0.077\text{m}$$

$$\text{Length of conveyor (m)} = 1.06\text{m}$$

$$\text{Length of the conveyor belt} = 0.93\text{m}$$

Basic belt length (m)	=	1.86m
Belt speed (m/s)	=	0.12m/s
Height of conveyor (m)	=	0.26m
Angle of inclination ($^{\circ}$)	=	0°
Conveyor capacity (tonnes/hr)	=	21 tonnes/hr
Belt tension while starting (KN)	=	166.97KN
Belt tension at steady state (KN)	=	154.6KN
Load due to idlers (kg/m)	=	12kg/m
Load due to belt (kg/m)	=	25kg/m
Load due to materials conveyed	=	48.6kg/m
Power at drive pulley (KW)	=	0.17KW
Drive efficiency	=	0.05
Idler spacing (m)	=	1.2m
Power required by conveyor	=	5.0KW
Torque (Nm)	=	4.95Nm
Material density (kg/m ³)	=	1000
Coefficient of friction	=	0.02
Belt thickness (mm)	=	1
Capacity factor	=	1.0
Roller diameter (mm)	=	40

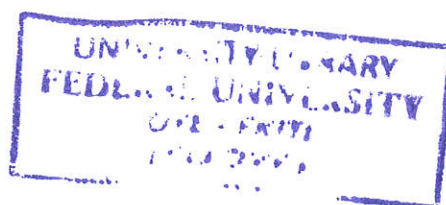

CHAPTER 4

RESULT AND DISCUSSION

4.1 RESULTS AND ANALYSIS

The outcome of the testing process carried out on the car washing process on the system is given in the table below.

The time taken to move the car to be washed from entry point to the washing unit is measured with a stop watch. The velocity of the conveyer belt is calculated from the reduced driving speed of 14Hz of the system. The total time recorded for completion of the car washing is also recorded for various cars. Fig 5.1 and Fig 5.2 represents the time analysis of the washing process. Total time consumed to complete the washing operation = Time at conveyer belt + Time at washing unit + delay. Delay time is the time taken for the car to move up and down the bridge of the washing station.

Table 4: Timing at each station for the implemented prototype

Task	Time (seconds)	Distance Travelled (mm)
Brushing	3	30
Rinsing	3	30
Drying	4	35
Total Duration	10	95

4.2 DISCUSSION

Successful experimental results were obtained from then previously described scheme indicating that the PLC can be used in automated conveyor belt systems. The monitoring control system of the induction motor by PLC proves its high accuracy in speed regulation at constant-speed-variable-load operation. Each rung of the program was executed perfectly which resulted to the operation of the required process at its respective station when the desired input is true. Initially when the supply is on, the VFD will start and the belt motor will be driven through the VFD. The VFD operated at a working frequency of 14Hz for the required speed of the motor. The efficiency obtained by using PLC control is increased as compared to the open-loop configuration of the induction motor fed by an inverter.

4.3 MAINTENANCE

In order to maintain the automatic car washing system, the following guidelines are recommended:

- i. The machine circuit breaker of the system must be turned off when not in use.
- ii. Sufficient and proper lubrication of the bearing should be carried out.
- iii. The machine should not be exposed to rainfall to minimize corrosion and damage of the components and sensors.

4.4 IMPLEMENTED PROTOTYPE



Figure 4.1: Implemented Prototype

CHAPTER 5

CONCLUSION AND RECOMMENDATIONS

5.1 CONCLUSION

We live in a constantly changing world; the progress never stops. Automation was created to reduce manpower, to make production process easier and increase its quantities at a shorter time. Automation can be experienced in different aspect of life especially transportation, as it is said to be the world's oldest humankind's activity, was very important field of production in past, it is so nowadays and will be in the future.

A PLC based machine designed specifically for washing the exterior of vehicles and also reducing water wastage by recycling. The automatic car washing system performs satisfactorily. It is efficient, easy to operate, cheap to maintain, low power consumption, high accuracy, requires little human interference and can be easily programmed. These features make it particularly suitable for the informal sectors like filling station, supermarket and mall where it can be used quickly accessed. Its short washing operation duration when compared to other means of car washing makes it a very viable business because people want their car washed quickly and efficiently without causing damage to it and without the fear of theft. It also reduced the issue of water wastage by increasing its recycling activities. One great advantage to be derived from the use of the system is that the process is automated. The simplicity of operation of the machine ensures that no special technical expertise is needed to operate the system. When the machine is well maintained, its durability is guaranteed. The machine maintenance cost is also lower when compared with existing washing means.

The PLC based automatic car washing system will also contribute favorably to environment and economic issues. The modification introduced in the design and operation of the automatic car washing system, if implemented will be beneficial and advantageous in the following:

- i. The issue of water pollution in the environment would be reduced.
- ii. The income generated from this business venture would be boosted because the car washing process is done in a short period of time and considering it is an automatic car wash system, it can wash as many cars as possible efficiently without the fear of errors.
- iii. The PLC system requires little maintenance cost.

5.2 HIGHLIGHTS OF IMPLEMENTATION:

- i) The system is running successfully through newly automated system.
- ii) The high accuracy and high productivity rate is achieved.
- iii) Frequent maintenance is not required.
- iv) System is monitored continuously; the fault occurrence if any can be cleared immediately without any delay.
- v) Since there is little human interference it leads to improved accuracy and productivity.
- vi) Overall System efficiency is improved after automation.

Thus, the PLC has proved to be a versatile and efficient control and monitoring tool in industrial electric drives applications.

5.3 RECOMMENDATION

This PLC based automatic car washing system is very suitable for the developing economy and environment. It is not only helpful in the quick exterior washing of the vehicle; it is also a solution to water pollution and contamination in the environment. For further research work, we recommend the following:

- The use of a Human Machine Interface (HMI) like control panel to monitor the entire system process and also troubleshoot and correct problems when necessary.
- The use of a belt in the conveyor system to transmit power from the motor to the roller to avoid friction and to ensure smooth motion of the belt when compared to the use of chain.
- To incorporate the use of a lift mechanism in the washing section to wash the underneath of the vehicle.

REFERENCES

- Akilandeswari, K. H. (March 2004). Implementation of Smart Car Washing Using GSM PLC.
IJRSTE, volume 3.
- Gurjot Singh Gaba, Nancy Gupta, et.al, (June 2012). Intelligent Cars using RFID Technology IJSER, ` volume 3, Issue.
- H. Janik, A. Kupiec, et. al, (May 2007). Trends in Modern Car Washing” Polish J. of Environ. Stud. Vol. 16, No. 6.
- Amir Hossein, DaeiSorkhabi, BitakHazini ,et.al, (July 2013). Manufacturing of Full Automatic Carwash Using with Intelligent Control Algorithms. International Journal of Mechanical, Aerospace, Industrial and Mechatronics Engineering Vol:7, No:3.
- Nader Barsoum, IzamFaizan Bin Moidi ,et.al, (2014). DC Motor Speed Control Using SMS Application. Intelligent Control and Automation, 5, 205-212.
- G.Subramanian K. Tharani Raja ,et.al, (2015). Simulation of Automatic Car Washing Using PLC, IJSRD International Journal for Scientific Research & Development| Vol. 3, Issue 01.
- N. M. Z. Hashim, M. H. A. Halim.et.al, (September 2013). Vehicle Security System Using Zigbee. International Journal of Scientific and Research Publications, Volume 3, Issue 9.
- Mr. AbhishekPansare, Ms. PriyankaYadav ,et.al, (April 2015). PLC Based Automatic Car Washing System. International Journal of Advance Engineering and Research Development Volume 2, Issue 4.
- International Carwash Association with University of Texas at Arlington, Texas (February 2012)
Research on hand washing vs automatic washing
- Vidyasagar K, Prasad R, Nagasekhar P. ,et.al, (June 2015). RFID-GSM Autonomous Car Washing System. International Journal of Computer Applications, Volume 121, Issue 2.
- ZHOU Ke-liang, et al. (December 2016). Research and design of self-service car-washing system based on ARM11 [J]: Transducer and Microsystem Technologies, Volume 6:107-108.

Mhaske D A, Bhavthankar R G, Saindane A R, et.al, (October 2016). PLC Based Car Washing System[J]. signal, Volume 4(4).

[www.youtube.com/programmed auto wash](http://www.youtube.com/programmed%20auto%20wash)

Muhammadali.V.V. (March 2013). Seminar on Automatic Car Washing System.

Janik, A. Kupiec, et.al, (August 2007). Trends in Modern Car Washing” Polish J. of Environ. Stud *IJRSTE*. Volume 16, No. 6.

Johnson, C. D., Prof. Mhaske D.A., Bhavthankar R.G, Saindane A. R., Darade D.J et.al, (April 2016) PLC Based Car Washing System”; International Journal Of Innovative Research In Electrical, Electronics, Process Control Instrumentation Technology, Prentice Hall, Instrumentation And Control Engineering Vol. 4, Issue 4, April 2016.

<http://en.wikipedia.org/wiki/carwash> carwash - Wikipedia, the free encyclopedia.

<http://www.epowerwash.com/wp/archives/481>>Spray Nozzles _ ePowerWash

Seema S. Vanamane, Pravin A. Mane et.al, (June 2012) Design, Manufacture and Analysis of Belt Conveyor System used for Cooling of Mould, www.ijera.com Vol. 2, Issue 3, pp.2162-2167

Appendix A

BILL OF ENGINEERING MATERIALS AND EVALUATION

No.	Components	Quality	Initial Cost	Total Cost (N)
1.	Logo PLC	1	30,000	30,000
2.	Communication cable	1	5,000	5,000
3.	IR sensors	6	800	5,000
4.	DC motor	4	1,850	7,500
5.	AC motor	1	8,000	8,000
6.	Conveyor Belt	1	5,000	5,000
7.	Dryer (fan)	3	1,500	4,500
8.	Tanks	2	1,500	3,000
9.	Relay	3	2,300	7,000
10.	Solenoid Valve	2	5,000	10,000
11.	Car	1	2,000	2,000
12.	Nozzles	Multiple	6,000	6,000
13.	Pipes	Multiple	7,000	7,000
14.	Pump	1	4,000	4,000
15.	Connector	3	1,000	3,000
16.	Indicator LED	2	2,500	5,000
17.	Circuit breaker	1	2,000	2,000
18.	Overload relay	1	5,000	5,000
19.	Wire mesh	-	3,000	3,000
20.	Variable frequency drive	1	25,000	25,000
21.	Screwdrivers	-	3,000	3,000
22.	Multimeter	1	2,000	2,000
23.	Connecting wire	Multiple	5,000	5,000
24.	Miscellaneous	-	15,000	15,000
25.	TOTAL			<u>N150,000</u>

TOTAL AMOUNT IN WORD – One Hundred and Fifty Thousand Naira Only

Appendix B
Electrical Circuit Design I

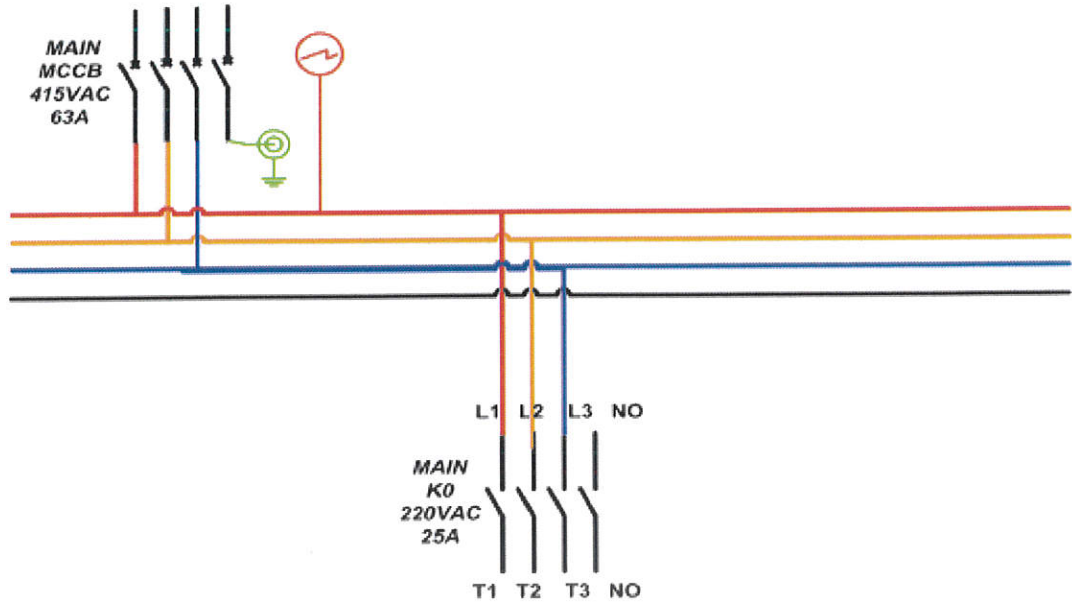

Electrical Circuit Design II

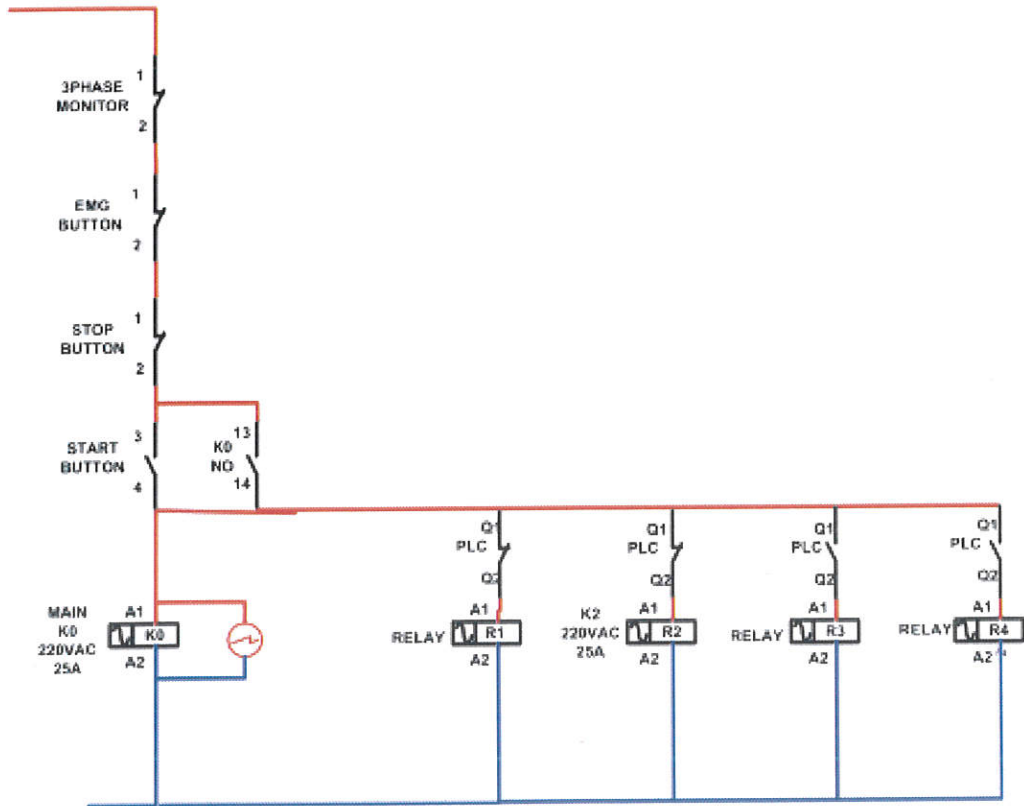

Electrical Circuit Design III

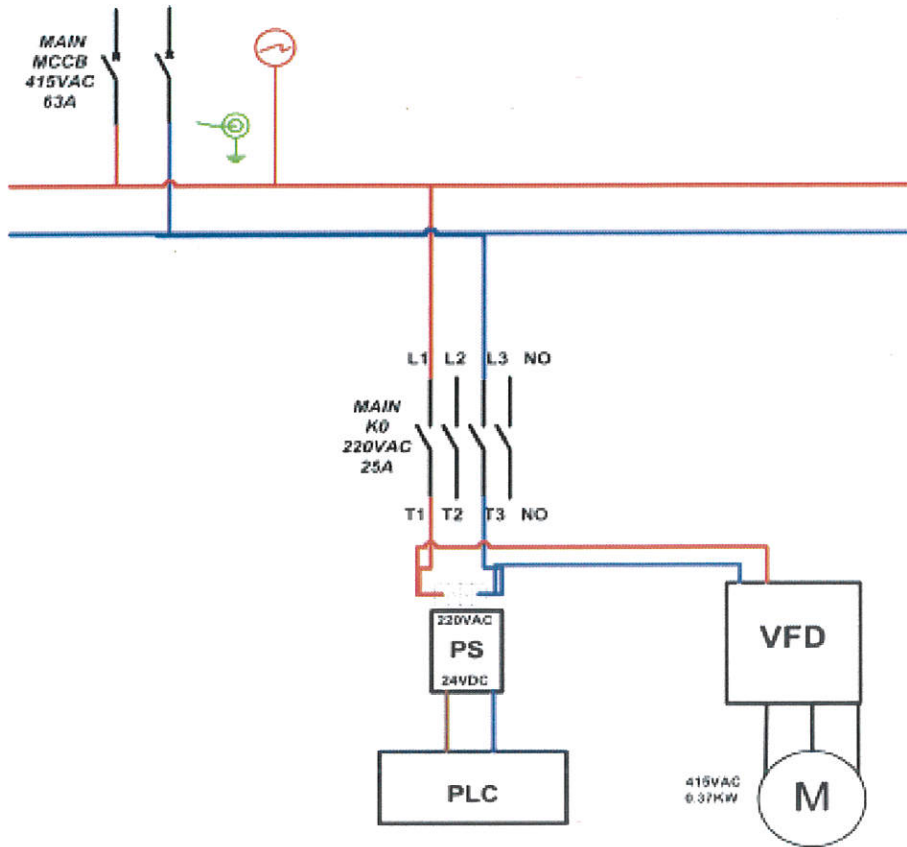

Appendix C

Control Section – Ladder Logic Programming

The screenshot displays the SIMATIC Manager interface for Ladder Logic Programming (LAD). The main window shows a project titled "OB1 : 'Main Program Sweep (Cycle)'" with the following components:

- Comment:** A greyed-out comment box.
- Network 1:** A comment box stating "Entering Section." and "When the start buton (Green switch) is pressed, it energize the running light (green indicator)and starts the car wash process". Below this is a ladder logic network with three rungs:
 - Rung 1: A normally open contact labeled "IO.1 Activate the operation 'Start'" in series with a normally closed contact labeled "IO.2 Stop the operation 'Stop'". This network is connected to a coil labeled "Q4.0 'Green lamp'".
 - Rung 2: A normally open contact labeled "Q4.0 'Green lamp'" in series with a normally open contact labeled "Q4.1 'Motor'". This network is connected to a coil labeled "Q4.2 Energize the conveyor".
 - Rung 3: A normally open contact labeled "Q4.2 Energize the conveyor" in series with a normally open contact labeled "Q4.1 'Motor'". This network is connected to a coil labeled "Q4.0 'Green lamp'".
- Network 2:** A comment box stating "Energize the conveyor" and "The running light Q4.0 energize the conveyor Q4.1 and the conveyor lamp Q4.2. The conveyor is controlled at a desired frequency through the variable frequency drive." Below this is a ladder logic network with two rungs:
 - Rung 1: A normally open contact labeled "IO.1 Activate the operation 'Start'" in series with a normally open contact labeled "Q4.0 'Green lamp'". This network is connected to a coil labeled "Q4.1 Energize the conveyor 'Motor'" and a timer coil labeled "T0".
 - Rung 2: A normally open contact labeled "Q4.1 Energize the conveyor 'Motor'" in series with a normally open contact labeled "Q4.2 Energize the conveyor". This network is connected to a coil labeled "Q4.2 Energize the conveyor".

The interface includes a left-hand menu with various logic elements like "New network", "Bit logic", "Comparator", "Converter", "Counter", "DB call", "Jumps", "Integer function", "Floating-point fct.", "Move", "Program control", "Shift/Rotate", "Status bits", "Timers", "Word logic", "FB blocks", "FC blocks", "SFB blocks", "SFC blocks", "Multiple instances", and "Libraries". The bottom status bar shows "offline", "Abs < 5.2", and "Insert". The taskbar at the very bottom shows the Windows taskbar with the time "10:49 PM".

LAD/STL/FBD - [OB1 - PracticeS7 Program(1)]

File Edit Insert PLC Debug View Options Window Help

IO 1: Activate the operation "Start"
 IO 2: Stop the operation "Stop"
 Q4.0: "Green lamp"
 Q4.1: Energize the conveyor "Motor"
 Q4.2: Energize the conveyor light "Yellow lamp"

Network 2: Energize the conveyor

The running light Q4.0 energize the conveyor Q4.1 and the conveyor lamp Q4.2. The conveyor is controlled at a desired frequency through the variable frequency drive.

Network 3: Washing Section.

The proximity sensor is used to detect the presence of the car. Car detection 1

LAD/SIL/FBD - [OB1 -- PracticeS7 Program(1)]

File Edit Insert PLC Debug View Options Window Help

the conveyor light "Yellow lamp"

Washing Section.

The proximity sensor is used to detect the presence of the car. Car detection 1 IO.3 senses the car and activate the brush Q4.3 and the washing water Q4.4 from pump 1. Also the recycling pump Q4.7 is energize to recycle the water back to the washing water section.

```

graph LR
    Q4_0[Q4.0 "Green lamp"] --- IO3[IO.3 "Car detection 1"]
    IO3 --- Q4_3[Q4.3 "Activate the brush Brush"]
    Q4_3 --- Q4_4[Q4.4 "Activate the pump Pump 1"]
    Q4_3 --- Q4_7[Q4.7 "recycling pump Pump 3"]
  
```

Network 4: Rinse Section.

Car detection 2 IO.4 senses the presence of the car and energise pump 2 Q 4.5 to spray clean water on the car. Also the recycling pump Q4.7 is energise to pump the water back to washing section once the water undergo the recycling process.

1: Error 2: Info 3: Cross-references 4: Address info 5: Modify 6: Diagnostics 7: Comparison

offline Abs <5.2 Nw 3 Insert

start SIMATIC Manager - [...] HW Config - [SIMATIC...] LAD/SIL/FBD - [OB1...]

10:50 PM